







barkman™

Specifications

2019



Contents



Pavers	3
Villa	4
Flagstone	5
Heartland	6
Verano	7
Holland	8
Roman	9
Roman Circle	10
Bullnose	10
Broadway 65mm	11
Holland 8cm	13
Boardwalk	13
Mesa Flagstone	14
Navarro	14
Cobble	15
Broadway 100mm	16
Turfstone Eco	18
Holland Eco	18
Colonial Eco	18
Paver Material Requirements	19
Slabs	20
Arborwood	21
Bridgewood	22
Terra Nova	22
Rosetta® Grand Flagstone 	23
Rosetta® Dimensional Flagstone 	24
Brookside Slab	24
Lexington Tile	25
Diamondface	26
Stepping Stones	26
Footing Pads	26
Walls	27
Bridgewood Wall	28
StackStone®	28
RomanStack®	28
Quarry Stone	29
Pisa2®	29
RomanPisa®	30
Rosetta® Belvedere 	30
Rosetta® Dimensional Wall 	31
Rosetta® Kodah 	31
Rosetta® Outcropping 	32
Architextures	32
Keystone Compac III	33
Durahold	33
Durahold 2	34
Retaining Wall Material Requirements	34
Finishing Touches	35
Pillar Caps	36
Villa Edger	36
Granite Edger	36
I-Con Edger	36

Polymeric Sand	37
Cleaners and Removers	37
Adhesive	37
Edge Restraint	38
Landscaping Materials	38
Installation Tools	38

Installation Recommendations **39**

Colours **40**

Landscape Kits **42**

Stone Oasis Fireplaces and Wood Storage	43
Stone Oasis Curved Bar	43
Stone Oasis Circle Patios	44
Modern Firepit	44
Stone Oasis Circle Firepit	45
Stone Oasis Square Firepit	45
Rosetta® Firepit Kits 	46
Stone Oasis Pillar Kits	46
Rosetta® Pillar Kits 	46
Harvest Grove Kitchen Kits	47
Harvest Grove Kitchen Kit Components	48

Site Furnishings **50**

Cast Planters	51
Cast Bench	51
Cast Bench with Back	52
Skyline Bench	52
One40Two Bench	52
One40Two Bench with Back	52
Park Bench	53
Plaza Bench	53
Wellington Bench	54
Brandon Bench	54
72" Rectangular Picnic Table	54
Cast Patio Table	55
Square Waste Container	55
Round Waste Container	55
Pebblestone Snuffers	56
Umbrella Base	56
Recycle Container	56



GFRC **57**

Elan Planters	57
Montana Planters	57
Santa Fe Planters	58
Newport Planters	58
Contempra Planters	59
Cube Planters	60
Self Watering Units	60
Trays	61
Waste Containers	61
Cube Garden Bench	61
GFRC Benches	62
Ash Urns	62

Specialty Products **63**

Bicycle Stands	63
Splash Pads	63
Rain Drain	63
Barrier Curbs	63
Highway Barrier Curbs	63
Curbs	64
Boat Ramp Pads	64
Pool Heater Pad	64

Steps **65**

Rosetta® Irregular Steps 	65
Rosetta® Dimensional Steps 	65
Bridgewood Steps	65
Sectional Steps	66
Sectional Brackets	67
Dura-Lite Steps 2.5" Plank Thickness	67
Dura-Lite Steps 4" Plank Thickness	67
Dura-Lite Concrete Pebblestone Planks	68
Legacy Steps	68
Cantilever Brackets	68

Septic Tanks **69**

Standard Septic Tanks	69
Septic Tank Manhole Extensions	69
Perma Septic Tanks	69
Septic Tank Accessories	69

Sump Pits **70**

Well Cribbing & Sump Pump Pit	70
-------------------------------	----

Pallet Return Guide **71**

Returnable Pallet	71
Unreturnable Pallet	71

Important Information **72**

The Environment	72
Lifetime Warranty	72
Quality and Support Pledge	72
How to Order	72
Installation and Project Estimation Support	72
Colour Blend Information	72
Product Changes for 2019	72

 Rosetta® Signature Collection

G2™

INTELLIGENT POLYMERIC SAND

NO DUST • HAZE FREE
NO BLOWER • ONE WATERING

NEW

**RAPID SET
TECHNOLOGY**

RAIN SAFE AFTER 15 MINUTES

OSHA
COMPLIANT

ASTM C-144

15 YEAR
LIMITED WARRANTY

Polybind Complete G2

AVAILABLE COLORS



Nevada
Tan

Oxford
Grey

Ivory
White

Jet
Black

G2™

INTELLIGENT POLYMERIC SAND



POLYBIND

BY ALLIANCE DESIGNER PRODUCTS

COMPLETE

NO DUST
HAZE FREE
NO BLOWER
ONE WATERING

**RAPID SET
TECHNOLOGY**

RAIN SAFE AFTER 15 MINUTES

OSHA
COMPLIANT

ASTM C-144

FOR PAVER & STONE JOINTS UP TO 4"
FOR OVERLAY & NON-OVERLAY APPLICATION

RESIDENTIAL & COMMERCIAL USE

15 YEAR
LIMITED WARRANTY



POLYBIND

BY ALLIANCE DESIGNER PRODUCTS

Polybind.com

Pavers



Whether it is a large or small project, Barkman Pavers offer a wide selection of options for your patio, walkway, driveway or parking space. Far from just looks, our pavers offer quality assurance through rigorous testing and the use of superior grade materials throughout the manufacturing process. We believe we have a paver for any aspiring design.

Pavers 50mm

Villa

DESCRIPTION	UNIT					PALLET ROW				PALLET				PRICE
	SIZE (L X W X H)		FACE AREA		WEIGHT	NO. OF UNITS	FACE AREA		NO. OF UNITS	NO. OF ROWS	FACE AREA		WEIGHT	
	MM	IN	M2	SQ FT	LB		M2	SQ FT			M2	SQ FT	LB	
Villa	299 x 149 x 51	11.77 x 5.87 x 2	.04	.48	11	60	2.68	28.8	240	4	10.59	114	2640	

COLOURS	ITEM NO.
Charcoal	119759
Sierra Grey	119757



Notes: Recommended to use **Paver Saver Mat (103164)** between plate compactor and surface at half speed. Use Polybind Complete G2 Polymeric Sand. A \$25.00 returnable pallet fee will be charged to any bundle of Villa.

PATTERNS

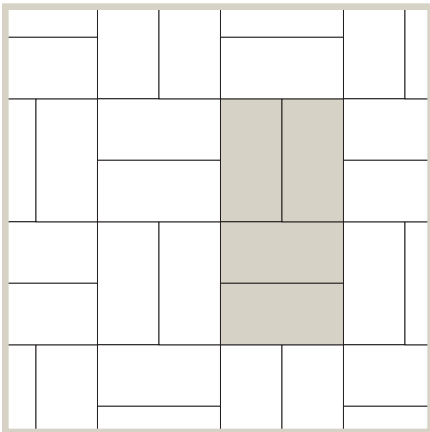

Parquet

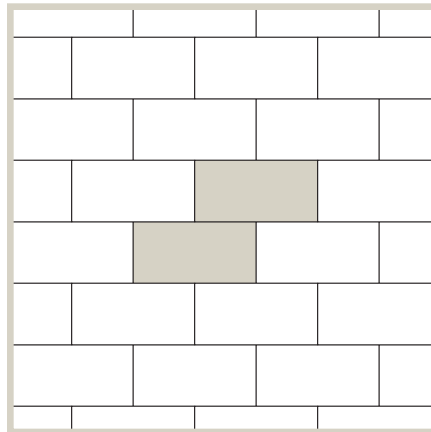

Running Bond

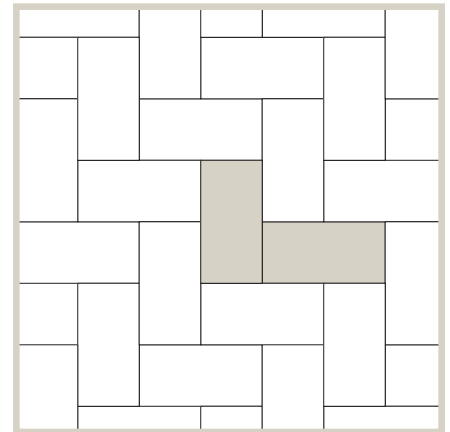

Herringbone

Pavers 60mm

Flagstone

DESCRIPTION	UNIT					PALLET ROW				PALLET				PRICE
	SIZE (L X W X H)		FACE AREA		WEIGHT	NO. OF UNITS	FACE AREA		NO. OF UNITS	NO. OF ROWS	FACE AREA		WEIGHT	
	MM	IN	M2	SQ FT	LB		M2	SQ FT			M2	SQ FT	LB	
Flagstone Paver	457.3 x 379.1/228 x 60	18 x 14.92/8.98 x 2.36	.11	1.21	35	-	-	-	80	-	9.01	97	2800	

COLOURS	ITEM NO.
Antique Brown	114579
Sierra Grey	114580
Old Town	114583

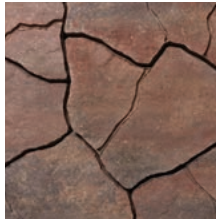

Notes: Available to order in full pallets only. Recommended to use **Paver Saver Mat (103164)** between plate compactor and surface. Each pallet has six different patterned blocks. Recommended to use Polybind Complete G2 Polymeric Sand to accommodate the false joints. A \$25.00 returnable pallet fee will be charged to any bundle of Flagstone. Custom order minimum quantity is 1000 sq ft. Contact your local Barkman sales representative for further details.

PATTERNS



Pavers 60mm

Heartland

DESCRIPTION	UNIT					PALLET ROW			PALLET				PRICE	
	SIZE (L X W X H)		FACE AREA		WEIGHT	NO. OF UNITS	FACE AREA		NO. OF UNITS	NO. OF ROWS	FACE AREA			WEIGHT
	MM	IN	M2	SQ FT	LB		M2	SQ FT			M2	SQ FT		LB
Heartland Paver	392 x 320 x 60	15.43 x 12.60 x 2.36	.10	1.09	29	-	-	-	90	-	9.10	98	2784	

COLOURS	ITEM NO.
Custom order	-



Notes: This is a non-stocking item. Custom order only. Available to order in full pallets only. Recommended to use **Paver Saver Mat (103164)** between plate compactor and surface. Each pallet contains four different patterned blocks. Recommended to use Polybind Complete G2 Polymeric Sand to accommodate the false joints. A \$25.00 returnable pallet fee will be charged to any bundle of Heartland. Custom order minimum quantity is 1000 sq ft. Contact your local Barkman sales representative for further details.

PATTERNS

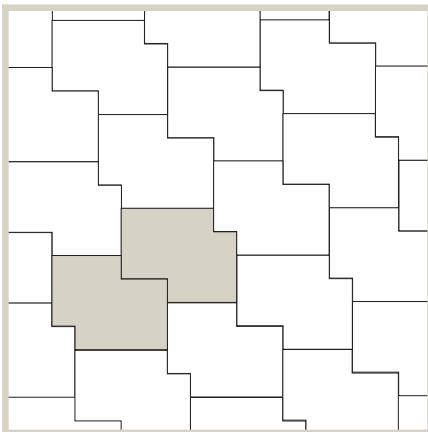

Pavers 60mm

Verano

DESCRIPTION	UNIT					PALLET ROW			PALLET				PRICE	
	SIZE (L X W X H)		FACE AREA		WEIGHT	NO. OF UNITS	FACE AREA		NO. OF UNITS	NO. OF ROWS	FACE AREA			WEIGHT
	MM	IN	M2	SQ FT	LB		M2	SQ FT			M2	SQ FT		LB
6x6	146.1 x 146.1 x 60	5.75 x 5.75 x 2.36	.02	.23	6	-	-	-	60	-	-	-	-	
12x6	292.1 x 146.1 x 60	11.5 x 5.75 x 2.36	.04	.46	13	-	-	-	60	-	8.92	96	2784	
12x12	292.1 x 292.1 x 60	11.5 x 11.5 x 2.36	.09	.92	25	-	-	-	60	-	-	-	-	

COLOURS	ITEM NO.	ITEM NO. NON CHAMFER
Antique Brown	103171	Custom order
Sierra Grey	103170	Custom order
Old Town	103172	Custom order
Charcoal	123156	Custom order



Notes: Each bundle contains 96 sq. ft. with all three sizes combined. Available to order in full pallets only. Verano is a non-tumbled paver with smooth face. A \$25.00 returnable pallet fee will be charged to any bundle of Verano. Custom order minimum quantity is 1000 sq ft. Contact your local Barkman sales representative for further details. The non-chamfer Verano paver is a custom order option that is ideal for American/Candian Disability Act (ADA/CDA) compliance. For more information, ask your local sales representative.

PATTERNS

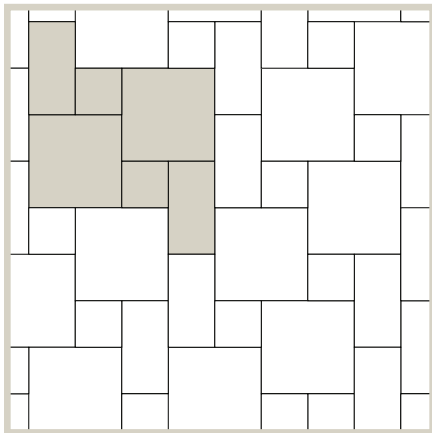

Pattern 1

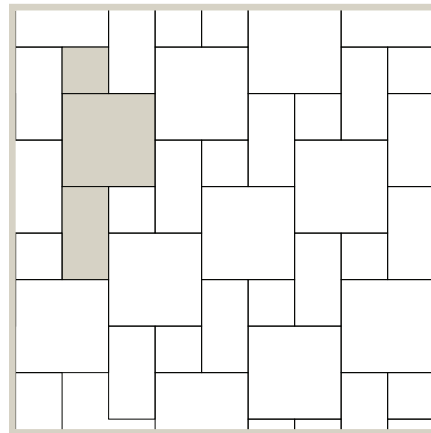

Pattern 2

Pavers 60mm

Holland

DESCRIPTION	UNIT					PALLET ROW				PALLET				PRICE
	SIZE (L X W X H)		FACE AREA		WEIGHT	NO. OF UNITS	FACE AREA		NO. OF UNITS	NO. OF ROWS	FACE AREA		WEIGHT	
	MM	IN	M2	SQ FT	LB		M2	SQ FT			M2	SQ FT	LB	
8x4	210 x 105 x 60	8.27 x 4.13 x 2.36	.02	.24	6.9	80	1.78	19.2	400	5	8.92	96	2784	
8x8	210 x 210 x 60	8.27 x 8.27 x 2.36	.04	.48	14	40	1.78	19.2	200	5	8.92	96	2784	

COLOURS	ITEM NO. 8X4	ITEM NO. 8X8
Natural	102720	-
Charcoal	102734	102801
Desert Buff	102742	-
Antique Brown	102740	-
Autumn Brown	102738	102804
Sierra Grey	102739	102805



Notes: Holland pavers can be installed in a running bond or herringbone pattern with border options that can be combined with other pavers. The patterns listed below can also be used on our 8CM Holland paver. To calculate soldier course, multiply lineal footage by .7; this will indicate the square footage of Holland required. To calculate sailor course, multiply lineal footage by .35, this will indicate the square footage of Holland required. A \$25.00 returnable pallet fee will be charged to any bundle of Holland. Contact your local Barkman sales representative for further details. Custom order minimum quantity is 1000 sq ft per size.

PATTERNS

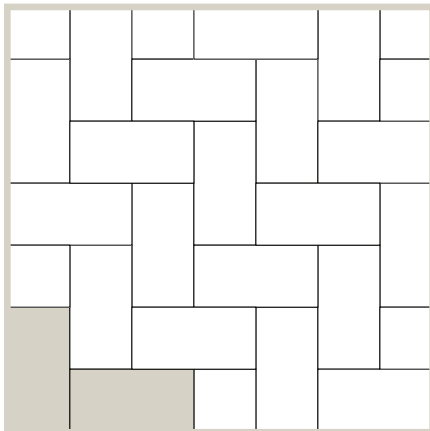

Herringbone

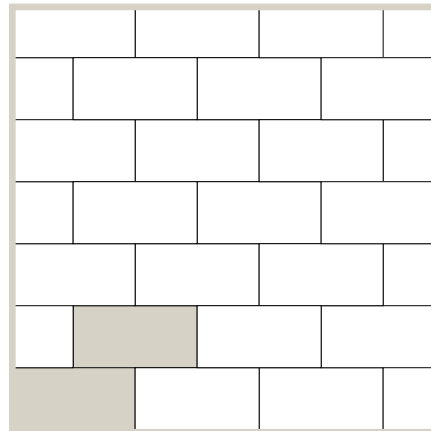

Running Bond

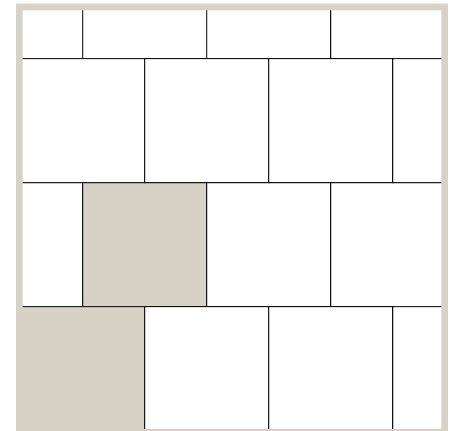

Running Bond

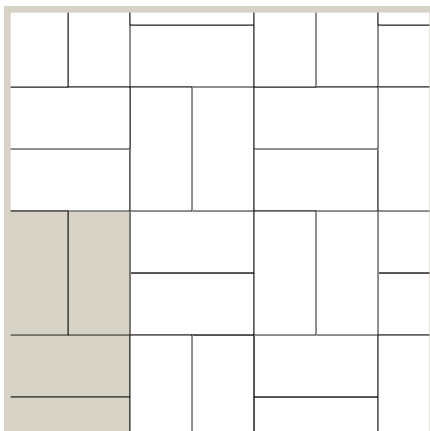

Parquet

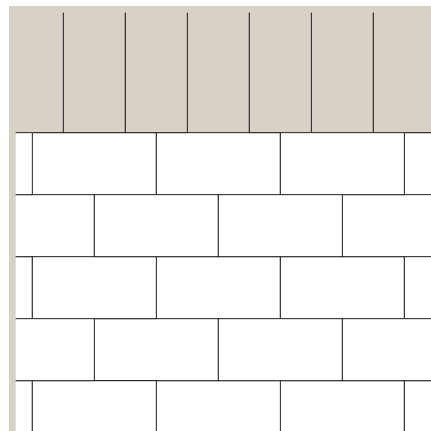

Soldier Course

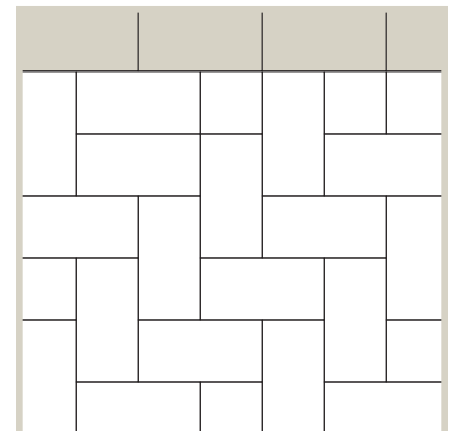

Sailor Course

Pavers 60mm

Roman

DESCRIPTION	UNIT					PALLET ROW				PALLET				PRICE
	SIZE (L X W X H)		FACE AREA		WEIGHT	NO. OF UNITS	FACE AREA		NO. OF UNITS	NO. OF ROWS	FACE AREA		WEIGHT	
	MM	IN	M2	SQ FT	LB		M2	SQ FT			M2	SQ FT	LB	
8x4	210 x 105 x 60	8.27 x 4.13 x 2.36	.02	.24	6.9	80	1.78	19.2	400	5	8.92	96	2784	
8x6	210 x 157.5 x 60	8.27 x 6.18 x 2.36	.03	.35	10.32	50	1.65	17.8	250	5	8.27	89	2581	
8x10	210 x 262.5 x 60	8.27 x 10.31 x 2.36	.05	.59	17	40	2.2	23.75	160	4	8.83	95	2755	
8x12	210 x 315 x 60	8.27 x 12.40 x 2.36	.07	.71	20.66	40	2.65	28.5	160	4	10.59	114	3306	

COLOURS	ITEM NO. 8X4	ITEM NO. 8X6	ITEM NO. 8X10	ITEM NO. 8X12
Charcoal	102978	102979	102976	102977
Desert Buff	103055	103056	102995	102996
Antique Brown	102984	102985	102982	102981
Sierra Grey	102992	102993	102980	102991
Old Town	102971	102972	102969	102970



Notes: Roman pavers are rectangular and come in four sizes on separate pallets. They can be installed using one size only in a running bond or herringbone pattern, or they can be installed by mixing the sizes to create a random pattern. A \$25.00 returnable pallet fee will be charged to any bundle of Roman. Contact your local Barkman sales representative for further details. Custom order minimum quantity is 1000 sq ft per size.

PATTERNS

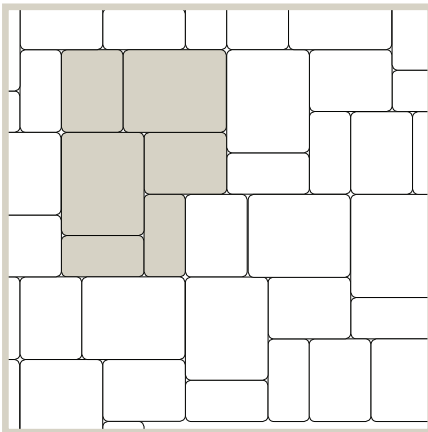

Pattern 1

Pieces per 100 sq. ft.

- 85 pieces: 8 x 10 = 50% of total area
- 85 pieces: 8 x 6 = 30% of total area
- 85 pieces: 8 x 4 = 20% of total area

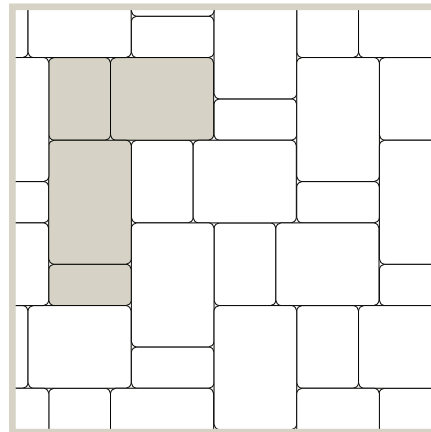

Pattern 2

Pieces per 100 sq. ft.

- 53 pieces: 8 x 12 = 38% of total area
- 53 pieces: 8 x 10 = 31% of total area
- 53 pieces: 8 x 6 = 19% of total area
- 53 pieces: 8 x 4 = 12% of total area

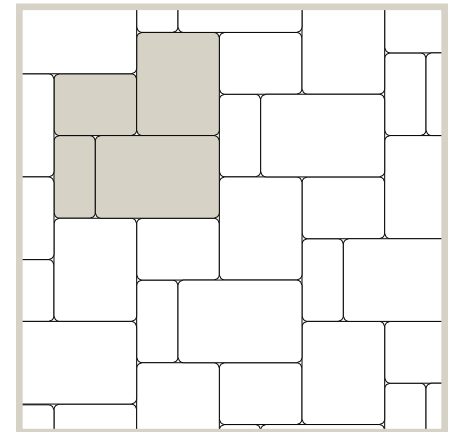

Pattern 3

Pieces per 100 sq. ft.

- 53 pieces: 8 x 12 = 38% of total area
- 53 pieces: 8 x 10 = 31% of total area
- 53 pieces: 8 x 6 = 19% of total area
- 53 pieces: 8 x 4 = 12% of total area

Pavers 60mm

Roman Circle

DESCRIPTION	UNIT					PALLET					PRICE
	SIZE (OUTSIDE DIAMETER X H)		FACE AREA		WEIGHT	NO. OF UNITS	NO. OF ROWS	FACE AREA		WEIGHT	
	MM	IN	M2	SQ FT	LB			M2	SQ FT	LB	
Roman Circle Bundle	3148 x 60	123.96 x 2.36	-	-	-	1	-	7.79	89	2607	

COLOURS	ITEM NO.
Charcoal	103124
Desert Buff*	103127
Antique Brown	103126
Sierra Grey	103125
Old Town*	103123

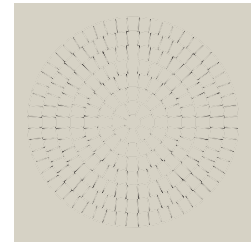

Notes: Available to order in full pallets only. Due to bundle configuration, customer will receive nine starter stones. Customer is not charged for extra starter stones. To expand Roman Circle past the 10.33 ft. diameter/89 sq. ft., please refer to chart below for quantities using 8x6 Roman pavers. Additional 8x6 courses will have larger gaps between stones. A \$25.00 returnable pallet fee will be charged to any bundle of Roman Circle. Custom order minimum quantity is 1000 sq ft. Contact your local Barkman sales representative for further details.

*Only available while quantities last.

COURSE NO.	SIZE		PIECES PER COURSE	TOTAL PIECES REQUIRED
	DIAMETER			
	M	FT		
8	3.57	11.71	67	67
9	3.99	13.08	75	142
10	4.41	14.46	84	226
11	4.82	15.83	92	318
12	5.25	17.21	101	419
13	5.66	18.58	109	528
14	6.08	19.96	117	645
15	7.42	21.33	126	771
16	6.92	22.71	134	905
17	7.34	24.08	142	1047
18	7.76	25.46	151	1198
19	8.18	26.83	159	1357
20	8.60	28.21	168	1525
21	9.02	29.58	176	1701
22	9.44	30.96	184	1885
23	9.85	32.33	193	2078
24	10.27	33.71	201	2279

Bullnose

DESCRIPTION	UNIT					PALLET				PRICE
	SIZE (L X W X H)		FACE AREA		WEIGHT	NO. OF UNITS	TOTAL LENGTH		WEIGHT	
	MM	IN	M2	SQ FT	LB		M	FT	LB	
Roman (Tumbled)	305 x 152 x 60	12 x 6 x 2.36	-	0.5	13	144	-	72	1872	
Smooth	305 x 152 x 60	12 x 6 x 2.36	-	0.5	13	144	-	72	1872	

COLOURS	ITEM NO. SMOOTH	ITEM NO. ROMAN
Charcoal	102691	113727

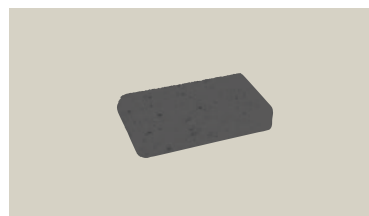

Notes: Product available to order in full pallets only. A \$25.00 returnable pallet fee will be charged to any bundle of Smooth and Roman Bullnose pavers. Custom order minimum quantity is 1000 sq ft. Contact your local Barkman sales representative for further details.

Pavers 65mm

Broadway 65mm

DESCRIPTION	UNIT					PALLET ROW			PALLET			PRICE	
	SIZE (L X W X H)		FACE AREA		WEIGHT	NO. OF UNITS	FACE AREA		NO. OF UNITS	FACE AREA			WEIGHT
	MM	IN	M2	SQ FT	LB		M2	SQ FT		M2	SQ FT		LB
300 x 150 x 65	300 x 150 x 65	11.81 x 5.90 x 2.56	.04	.48	16	-	-	-	240	10.7	115	3840	
300 x 300 x 65	300 x 300 x 65	11.81 x 11.81 x 2.56	.09	.97	31	-	-	-	90	8.11	87	2790	
600 x 300 x 65	600 x 300 x 65	23.62 x 11.81 x 2.56	.18	1.94	53	-	-	-	60	10.81	116	3168	
600 x 600 x 65	600 x 600 x 65	23.62 x 23.62 x 2.56	.36	3.87	116	-	-	-	20	7.15	77	2320	

COLOURS FACE MIX	ITEM NO. 300 X 150	ITEM NO. 300 X 300	ITEM NO. 600 X 300	ITEM NO. 600 X 600
Natural	134990	134989	134988	134987
Charcoal	134994	134993	134992	134991
Sterling	134998	134997	134996	134995
Perfetto Regency White	136645	136644	136642	136643
Perfetto Cosmo Black	135045	135043	135039	135041
Ash (Custom order)				



Notes: Available to order in full pallets only. A \$25.00 returnable pallet fee will be charged to any bundle of Broadway 65mm. Contact your local Barkman sales representative for further details. Custom order minimum quantity is 1000 sq ft per size.

PATTERNS

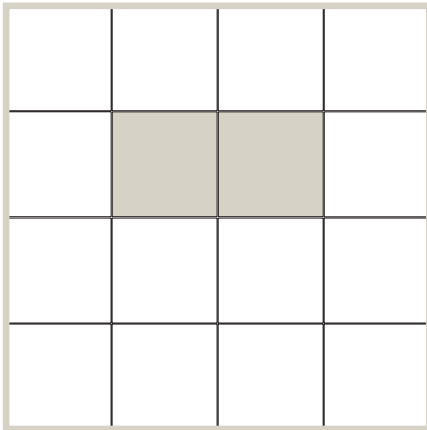

Pattern 1

Pieces per 100 sqft

(1) 300x300 = 100%, 103 pcs

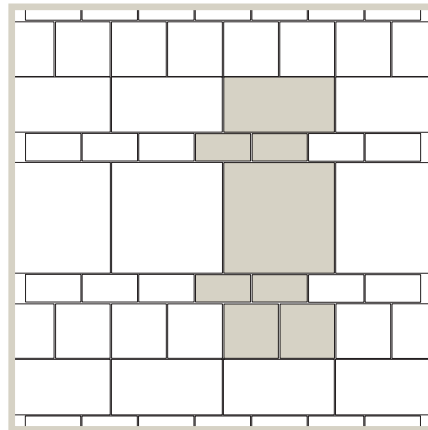

Pattern 2

Pieces per 100 sqft

(4) 300 x 150 = 20%, 42 pcs
 (2) 300 x 300 = 20%, 21 pcs
 (1) 600 x 300 = 20%, 10 pcs
 (1) 600 x 600 = 40%, 10 pcs

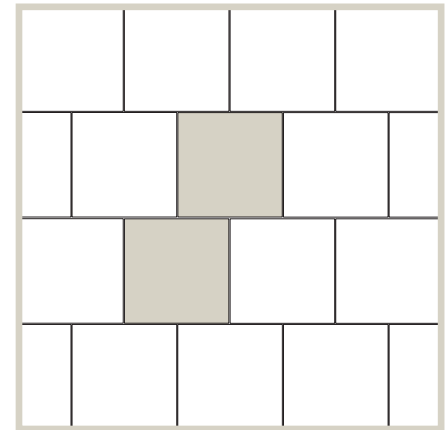

Running Bond

Pieces per 100 sqft

(1) 300x300 = 100%, 103 pcs

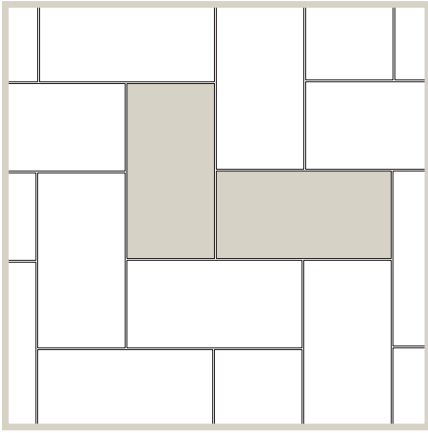

Herringbone

Pieces per 100 sqft

(1) 300 x 150 = 100%, 208 pcs

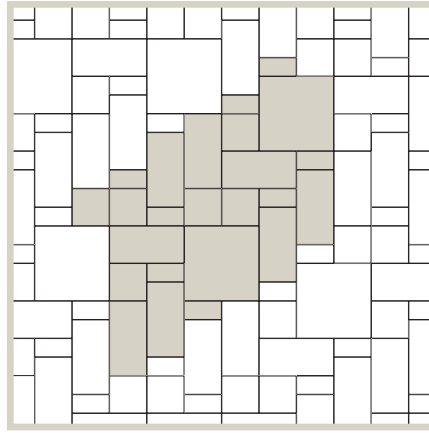

Pattern 5

Pieces per 100 sqft

(8) 300 x 150 = 12%, 24 pcs

(6) 300 x 300 = 18%, 18 pcs

(8) 600 x 300 = 47%, 24 pcs

(2) 600 x 600 = 23%, 6 pcs

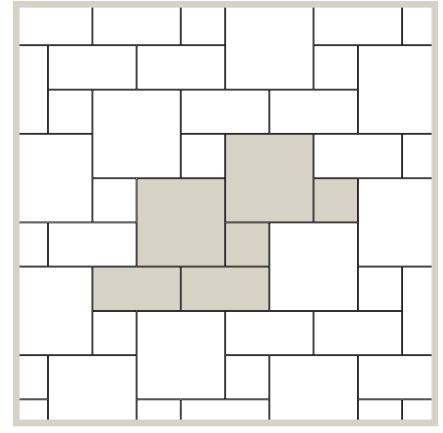

Pattern 6

Pieces per 100 sqft

(1) 300 x 300 = 14%, 15 pcs

(1) 600 x 300 = 29%, 15 pcs

(1) 600 x 600 = 57%, 15 pcs

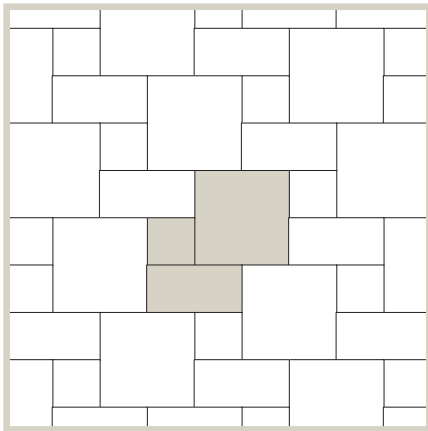

Pattern 7

Pieces per 100 sqft

(1) 300 x 300 = 14%, 15 pcs

(1) 600 x 300 = 29%, 15 pcs

(1) 600 x 600 = 57%, 15 pcs

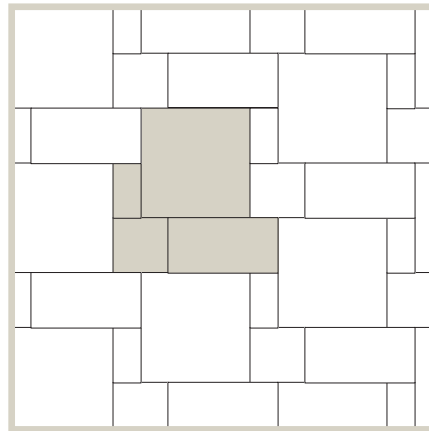

Pattern 8

Pieces per 100 sqft

(1) 300 x 150 = 7%, 14 pcs

(1) 300 x 300 = 13%, 14 pcs

(1) 600 x 300 = 27%, 14 pcs

(1) 600 x 600 = 53%, 14 pcs

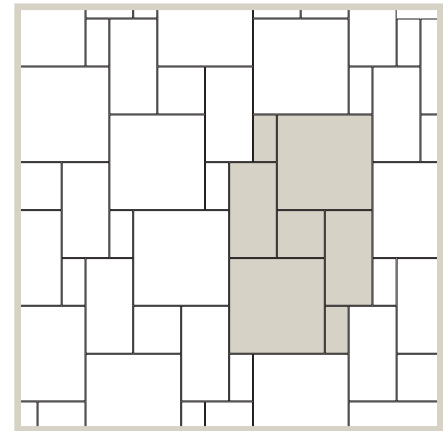

Pattern 9

Pieces per 100 sqft

(2) 300 x 150 = 7%, 15 pcs

(1) 300 x 300 = 7%, 7 pcs

(2) 600 x 300 = 29%, 15 pcs

(2) 600 x 600 = 57%, 15 pcs

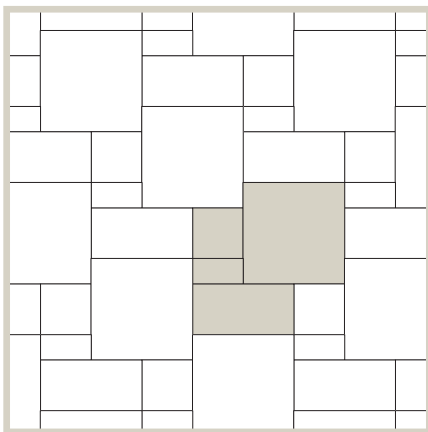

Pattern 10

Pieces per 100 sqft

(1) 300 x 150 = 7%, 14 pcs

(1) 300 x 300 = 13%, 14 pcs

(1) 600 x 300 = 27%, 14 pcs

(1) 600 x 600 = 53%, 14 pcs

Pavers 80mm

Holland 8CM

DESCRIPTION	UNIT					PALLET ROW				PALLET				PRICE
	SIZE (L X W X H)		FACE AREA		WEIGHT	NO. OF UNITS	FACE AREA		NO. OF UNITS	NO. OF ROWS	FACE AREA		WEIGHT	
	MM	IN	M2	SQ FT	LB		M2	SQ FT			M2	SQ FT	LB	
Holland 8CM	210 x 105 x 80	8.27 x 4.13 x 3.15	.02	.24	9.3	64	1.41	15.20	320	5	7.15	77	2976	

COLOURS	ITEM NO.
Natural*	102753
Charcoal	102752



Notes: Recommended to use Polybind Complete G2 Polymeric Sand for commercial applications. See Holland on page 8 for patterns. A \$25.00 returnable pallet fee will be charged to any bundle of Holland 8CM. Custom order minimum quantity is 1000 sq ft. Contact your local Barkman sales representative for further details.

*Only available while quantities last.

Boardwalk

DESCRIPTION	UNIT					PALLET ROW				PALLET				PRICE
	SIZE (L X W X H)		FACE AREA		WEIGHT	NO. OF UNITS	FACE AREA		NO. OF UNITS	NO. OF ROWS	FACE AREA		WEIGHT	
	MM	IN	M2	SQ FT	LB		M2	SQ FT			M2	SQ FT	LB	
14x4.5	362 x 119 x 80	14.25 x 4.69 x 3.15	.04	.44	17.17	-	-	-	28	-	7.06	76	2888	
14x3	362 x 89 x 80	14.25 x 3.50 x 3.15	.03	.32	13.15	-	-	-	28	-				
12.5x4.5	322 x 119 x 80	12.68 x 4.69 x 3.15	.04	.39	15.69	-	-	-	28	-				
12.5x3	322 x 89 x 80	12.68 x 3.50 x 3.15	.03	.29	11.70	-	-	-	28	-				
11x4.5	282 x 119 x 80	11.10 x 4.69 x 3.15	.03	.34	13.76	-	-	-	28	-				
11x3	282 x 89 x 80	11.10 x 3.50 x 3.15	.02	.25	10.26	-	-	-	28	-				
9x4.5	242 x 119 x 80	9.53 x 4.69 x 3.15	.03	.29	11.82	-	-	-	28	-				
9x3	242 x 89 x 80	9.53 x 3.50 x 3.15	.02	.21	8.82	-	-	-	28	-				

COLOURS	ITEM NO.
Shoreline Slate	113575

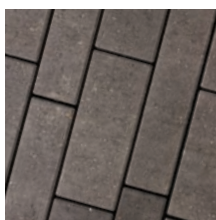

Notes: Each bundle contains 76 sq. ft. between the eight sizes. Recommended to use **Paver Saver Mat (103164)** between the plate compactor and surface. Boardwalk is compatible with some machine paver laying systems. Boardwalk can also be installed as a permeable paver. Available to order in full pallets only. Recommended to use Polybind Complete G2 Polymeric Sand for commercial applications if not using for permeable. A \$25.00 returnable pallet fee will be charged to any bundle of Boardwalk. Custom order minimum quantity is 1000 sq ft. Contact your local Barkman sales representative for further details. Product designed to be installed in a running bond pattern.

PATTERNS

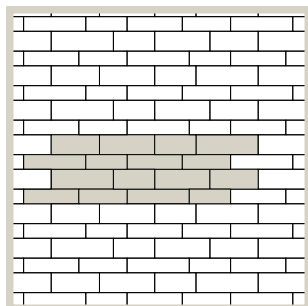

Pavers 80mm

Mesa Flagstone

DESCRIPTION	UNIT					PALLET ROW				PALLET				PRICE
	SIZE (L X W X H)		FACE AREA		WEIGHT	NO. OF UNITS	FACE AREA		NO. OF UNITS	NO. OF ROWS	FACE AREA		WEIGHT	
	MM	IN	M2	SQ FT	LB		M2	SQ FT			M2	SQ FT	LB	
Mesa Flagstone	613.3 x 330.8 x 80	24.14 x 13.02 x 3.15	.15	1.62	58	-	-	-	48	-	7.2	78	2784	

COLOURS	ITEM NO.
Sierra Grey	122616
Old Town	122617
Sterling	122888

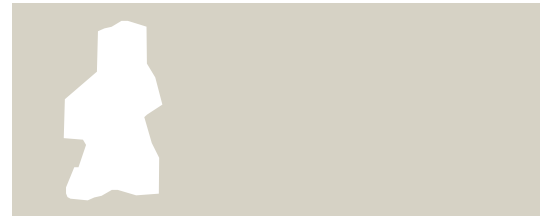

Notes: Available to order in full pallets only. Recommended to use **Paver Saver Mat (103164)** between plate compactor and paver surface. Recommended to use Alliance Polybind Complete G2 sand to accommodate the false joints. A \$25.00 returnable pallet fee will be charged to any bundle of Mesa Flagstone. Custom order minimum quantity is 1000 sq ft. Contact your local Barkman sales representative for further details.

Navarro

DESCRIPTION	UNIT					PALLET ROW				PALLET				PRICE
	SIZE (L X W X H)		FACE AREA		WEIGHT	NO. OF UNITS	FACE AREA		NO. OF UNITS	NO. OF ROWS	FACE AREA		WEIGHT	
	MM	IN	M2	SQ FT	LB		M2	SQ FT			M2	SQ FT	LB	
12x6	306 x 153 x 80	12.05 x 6.02 x 3.15	.05	.5	19	-	-	-	35	-	-	-	-	
12x12	306 x 306 x 80	12.05 x 12.05 x 3.15	.09	1	38	-	-	-	35	-	7.80	84	3100	
12x18	306 x 459 x 80	12.05 x 18.07 x 3.15	.14	1.50	57	-	-	-	21	-	-	-	-	

COLOURS	ITEM NO.
Antique Brown	102717
Sierra Grey	102719
Ebony	123155

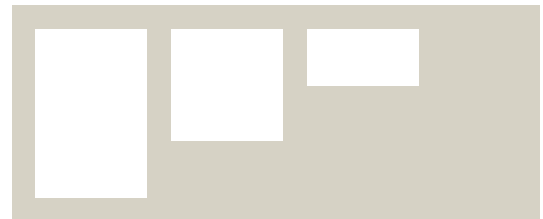

Notes: Available to order in full pallets only. Each bundle contains 84 sq. ft. between the three sizes. Recommended to use **Paver Saver Mat (103164)** between plate compactor and surface. Recommended to use Polybind Complete G2 Polymeric Sand for commercial applications. A \$25.00 returnable pallet fee will be charged to any bundle of Navarro. Custom order minimum quantity is 1000 sq ft. Contact your local Barkman sales representative for further details.

PATTERNS

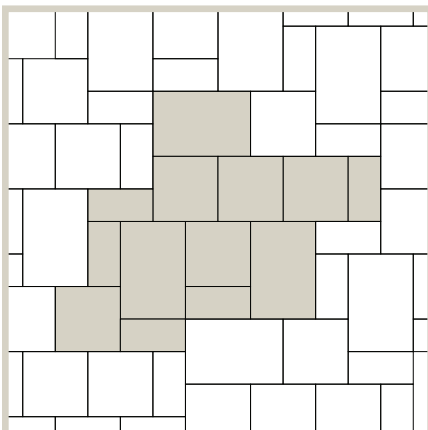

Pavers 80mm

Cobble

DESCRIPTION	UNIT					PALLET ROW				PALLET			PRICE	
	SIZE (L X W X H)		FACE AREA		WEIGHT	NO. OF UNITS	FACE AREA		NO. OF UNITS	NO. OF ROWS	FACE AREA			WEIGHT
	MM	IN	M2	SQ FT	LB		M2	SQ FT			M2	SQ FT		LB
7x6	180 x 150 x 80	7.09 x 5.91 x 3.15	.03	.29	-	-	-	-	56	-	7.99	86	2870	
9x6	220 x 150 x 80	8.66 x 5.91 x 3.15	.03	.35	-	-	-	-	56	-				
10x6	260 x 150 x 80	10.24 x 5.91 x 3.15	.04	.40	-	-	-	-	56	-				
12x6	300 x 150 x 80	11.81 x 5.91 x 3.15	.04	.45	-	-	-	-	56	-				

COLOURS	ITEM NO.
Ebony	117635
Sierra Grey	117251

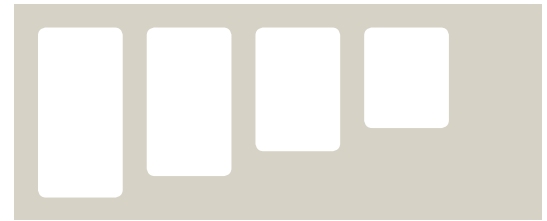

Notes: Each pallet contains seven layers with four different sizes. Recommended to use **Paver Saver Mat (103164)** between plate compactor and surface. This product is laid completely random within a running bond pattern. Recommended to use Polybind Complete G2 Polymeric Sand for commercial applications that are not permeable. Available to order in full pallets only. A \$25.00 returnable pallet fee will be charged to any bundle of Cobble. Custom order minimum quantity is 1000 sq ft. Contact your local Barkman sales representative for further details.

Pavers 100mm

Broadway 100mm

DESCRIPTION	UNIT					PALLET ROW			PALLET				PRICE	
	SIZE (L X W X H)		FACE AREA		WEIGHT	NO. OF UNITS	FACE AREA		NO. OF UNITS	NO. OF ROWS	FACE AREA			WEIGHT
	MM	IN	M2	SQ FT	LB		M2	SQ FT			M2	SQ FT		LB
451 x 76 x 100	451 x 76 x 100	17.76 x 2.99 x 3.94	.03	.33	17.28	-	-	-	132	-	4.37	47	2280	
300 x 150 x 100	300 x 150 x 100	11.81 x 5.91 x 3.94	.05	.48	22.93	-	-	-	90	-	4	43	2064	
300 x 300 x 100	300 x 300 x 100	11.81 x 11.81 x 3.94	.09	.97	46.22	-	-	-	72	-	6.5	70	3328	
600 x 300 x 100	600 x 300 x 100	23.62 x 11.81 x 3.94	.18	1.97	92	-	-	-	36	-	6.5	70	3312	
900 x 450 x 100	900 x 450 x 100	35.43 x 17.71 x 3.94	0.4	4.33	198	-	-	-	12	-	4.82	52	2376	
900 x 900 x 100	900 x 900 x 100	35.43 x 35.43 x 3.94	0.8	8.7	398	-	-	-	6	-	4.82	52	2388	

COLOURS	ITEM NO. 451X76	ITEM NO. 300X150	ITEM NO. 300X300	ITEM NO. 600X300	ITEM NO. 900X450	ITEM NO. 900X900
FACE MIX						
Charcoal	135309	135310	135311	135312	135313	135314
Natural	135315	135316	135317	135318	135319	135320
Sterling	135321	135322	135323	135324	135325	135326
Perfetto						
Regency White	136656	136657	136658	136659	136660	136661
Perfetto Cosmo Black	136650	136651	136652	136653	136654	136655
Ash (Custom order)						
THRU MIX						
Charcoal	114570	102849	113183	112503		
Natural	114576	102851	102852	102853		

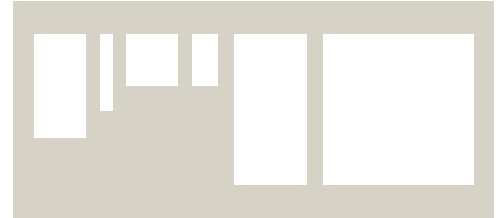

Notes: Available to order in full pallets only. Recommended to use Polybind Complete G2 Polymeric Sand for commercial application. A \$25.00 returnable pallet fee will be charged to any bundle of Broadway. Custom order minimum quantity is 1000 sq ft per size. Contact your local Barkman sales representative for further details.

PATTERNS

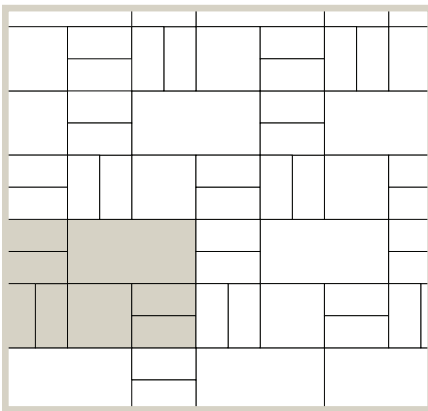

Pattern 1

Pieces per 100 Sqft

- (6) 150 x 300 = 50%, 102 pcs
- (1) 300 x 300 = 17%, 17 pcs
- (1) 600 x 300 = 33%, 17 pcs

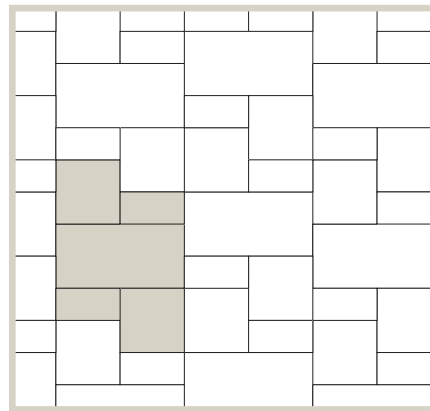

Pattern 2

Pieces per 100 Sqft

- (2) 150 x 300 = 20%, 42 pcs
- (1) 300 x 300 = 40%, 42 pcs
- (1) 600 x 300 = 40%, 21 pcs

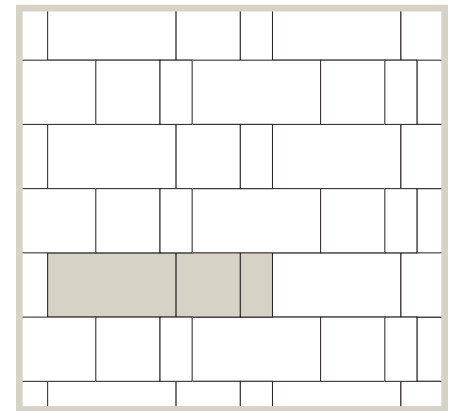

Pattern 3

Pieces per 100 Sqft

- (1) 150 x 300 = 14%, 29 pcs
- (1) 300 x 300 = 29%, 29 pcs
- (1) 600 x 300 = 57%, 29 pcs

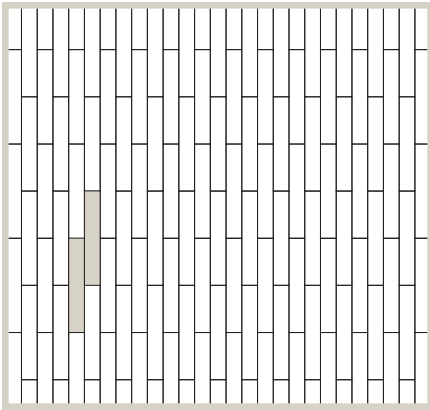

Running Bond

Pieces per 100 sqft
 (1) 451 x 76 = 100%, 303 pcs

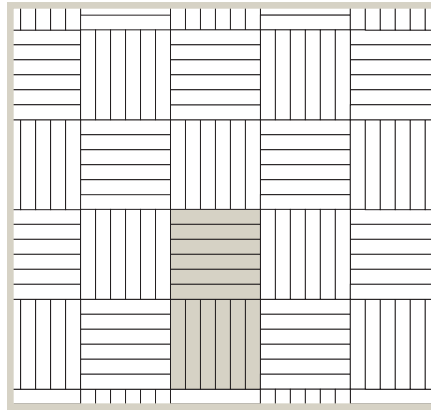

Parquet

Pieces per 100 sqft
 (1) 451 x 76 = 100%, 303 pcs

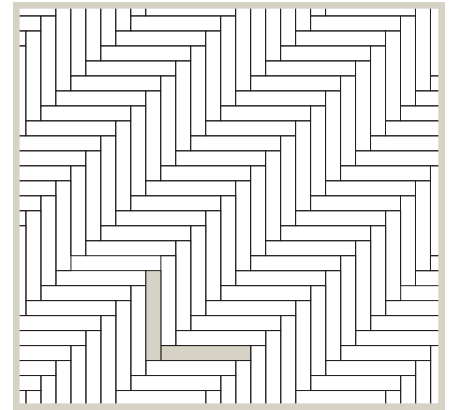

Herringbone

Pieces per 100 sqft
 (1) 451 x 76 = 100%, 303 pcs

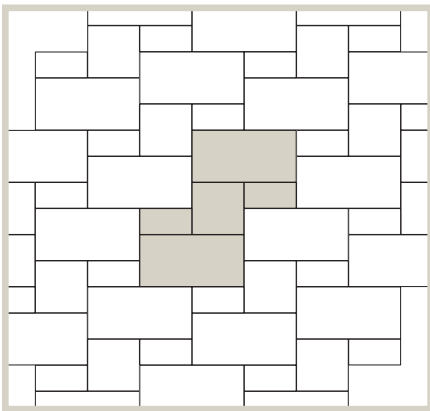

Pattern 7

Pieces per 100 Sqft
 (2) 300 x 150 = 16.5%, 34 pcs
 (1) 300 x 300 = 16.5%, 17 pcs
 (2) 600 x 300 = 67%, 34 pcs

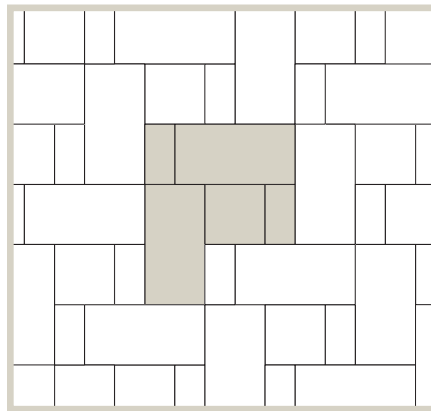

Pattern 8

Pieces per 100 Sqft
 (2) 300 x 150 = 16.5%, 34 pcs
 (1) 300 x 300 = 16.5%, 17 pcs
 (2) 600 x 300 = 67%, 34 pcs

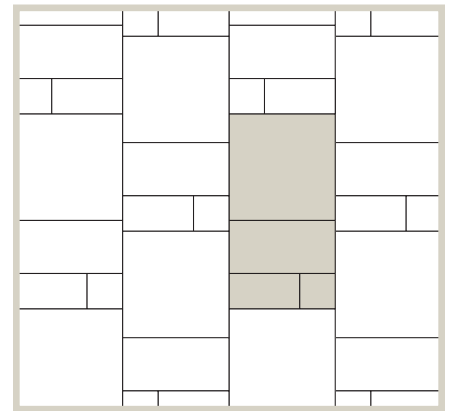

Pattern 9

Pieces per 100 Sqft
 (1) 900 x 900 = 54%, 7 pcs
 (1) 900 x 450 = 27%, 7 pcs
 (1) 600 x 300 = 13%, 7 pcs
 (1) 300 x 300 = 6%, 7 pcs

Pavers ECO

Turfstone Eco

DESCRIPTION	UNIT					PALLET ROW				PALLET				PRICE
	SIZE (L X W X H)		FACE AREA		WEIGHT	NO. OF UNITS	FACE AREA		NO. OF UNITS	NO. OF ROWS	FACE AREA		WEIGHT	
	MM	IN	M2	SQ FT	LB		M2	SQ FT			M2	SQ FT	LB	
Turfstone Eco	599 x 399 x 80	23.58 x 15.71 x 3.15	.24	2.58	64.5	16	3.84	41.28	32	2	7.62	82	2064	

COLOURS	ITEM NO.
Natural	102846



Notes: A \$25.00 returnable pallet fee will be charged to any bundle of Turfstone Eco. Contact your local Barkman sales representative for further details.

Holland Eco

DESCRIPTION	UNIT					PALLET ROW				PALLET				PRICE
	SIZE (L X W X H)		FACE AREA		WEIGHT	NO. OF UNITS	FACE AREA		NO. OF UNITS	NO. OF ROWS	FACE AREA		WEIGHT	
	MM	IN	M2	SQ FT	LB		M2	SQ FT			M2	SQ FT	LB	
Holland Eco	210 x 105 x 80	8.27 x 4.13 x 3.15	.02	.24	9.05	-	-	-	320 full	-	7.15	77	2888	
									64 half					

COLOURS	ITEM NO.
Custom order	-

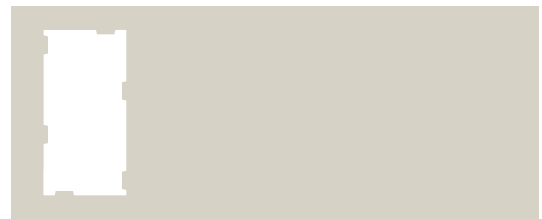

Notes: This is a non-stocking item, custom order only. Please contact Barkman for colour availability. The 64 half stones included in each pallet is not charged. See Holland on page 9 for patterns. A \$25.00 returnable pallet fee will be charged to any bundle of Holland Eco. Custom order minimum quantity is 1000 sq ft. Contact your local Barkman sales representative for further details.

Colonial Eco

DESCRIPTION	UNIT					PALLET ROW				PALLET				PRICE
	SIZE (L X W X H)		FACE AREA		WEIGHT	NO. OF UNITS	FACE AREA		NO. OF UNITS	NO. OF ROWS	FACE AREA		WEIGHT	
	MM	IN	M2	SQ FT	LB		M2	SQ FT			M2	SQ FT	LB	
Colonial Eco	157 x 157 x 80	6.18 x 6.18 x 3.15	.03	.27	9	40	1.04	11.20	280	7	7.25	78	2574	

COLOURS	ITEM NO.
Custom order	-



Notes: This is a non-stocking item, custom order only. Please contact Barkman for colour availability. A \$25.00 returnable pallet fee will be charged to any bundle of Colonial Eco. Custom order minimum quantity is 1000 sq ft. Contact your local Barkman sales representative for further details.

Pavers

Paver Material Requirements

1) EXCAVATION DEPTH

MATERIAL	FOR PEDESTRIAN TRAFFIC		FOR LIGHT VEHICULAR TRAFFIC	
	MM	IN	MM	IN
Pavers	60	2.36	60	2.36
Sand	25.4	1	25.4	1
Gravel Base	102–152	4–6	203–305	8–12
Total Excavation Depth	178–229	7–9	279–381	11–15

Gravel base: Use minimum depths in a well-drained area or undisturbed soil. Use maximum depths in poorly drained area or distributed soil. 0.5" less is required to compensate compacting of pavers. If soil is saturated more than 50% of the time, filter fabric and extra base should be used.

When installing thicker pavers (Broadway 100mm, Boardwalk, Navarro, Holland 8CM, Cobble, Mesa Flagstone) add 0.75" to 1.625" total excavation depth. Note that not all 60mm pavers are suitable for vehicular traffic (see page 39).

2) BASE MATERIAL

Granular Base

WIDTH				LENGTH		BASE DEPTH		MATERIAL REQUIRED	
m	x	m	x	$m \div .3048$	\div	.6858	=	m^3	
ft	x	ft	x	$ft \div 12$	\div	27	=	cu yd	

Bedding Sand

WIDTH				LENGTH		MATERIAL REQUIRED	
m	x	m	x	.0255	=	m^3	
ft	x	ft	x	0.0031	=	cu yd	

3) EDGING

Edging

LENGTH OF EDGE				SNAP EDGE	
m	\div	2.4384	=	No. of Pieces	
ft	\div	8	=	No. of Pieces	

Spikes

LENGTH OF EDGE				SPIKES	
m	\div	3.2808	=	No. of Spikes	
ft	x	1	=	No. of Spikes	

Slabs

From the rustic wood grains of Bridgewood to the bold colours and textures of Lexington, Barkman offers a wide variety of slabs to suit any architectural style.

Slabs

Arborwood (NEW)

DESCRIPTION	UNIT					PALLET			PRICE	
	SIZE (L X W X H)		FACE AREA		WEIGHT	NO. OF UNITS	FACE AREA			WEIGHT
	MM	IN	M2	SQ FT	LB		M2	SQ FT		LB
Arborwood	800 x 200 x 60	31.5 x 7.87 x 2.36	.16	1.72	47.4	50	7.99	86	2370	

COLOURS	ITEM NO.
Kodiak Brown	138915
Timber Wolf Grey	138916

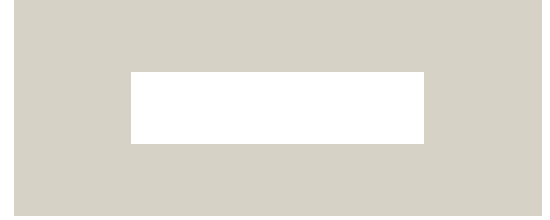

Notes: Available to order in full pallets only. A \$25.00 returnable pallet fee will be charged to any bundle of Arborwood.

PATTERNS

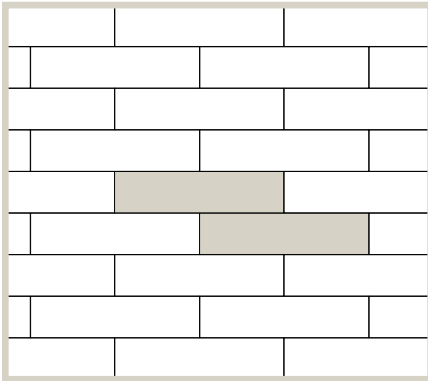

1/2 Offset

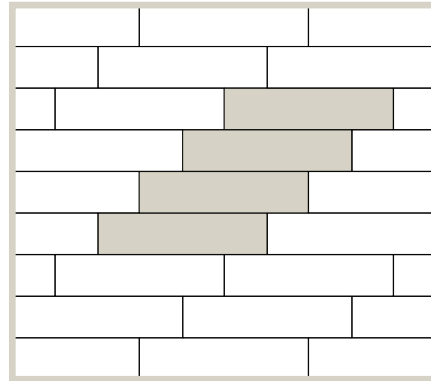

1/4 Offset

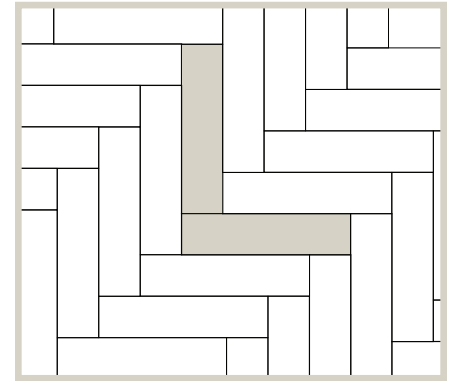

Herringbone

Slabs

Bridgewood

DESCRIPTION	UNIT						PALLET					PRICE
	SIZE (L X W X H)		FACE AREA		WEIGHT	NO. OF UNITS	NO. OF ROWS	FACE AREA		WEIGHT		
	MM	IN	M2	SQ FT	LB			M2	SQ FT	LB		
17x10	440 x 250 x 51	17.32 x 9.84 x 2	.11	1.18	28.5	40	-	4.39	47.2	1140		
23x10	595 x 250 x 51	23.43 x 9.84 x 2	.15	1.6	38.5	20	-	2.97	32	770		
35x10	890 x 250 x 51	35.04 x 9.84 x 2	.22	2.39	58	20	-	4.45	47.9	1160		

COLOURS	ITEM NO. 17X10	ITEM NO. 23X10	ITEM NO. 35X10
Cedar Brown	114278	114280	114282
Weathered Grey	114277	114279	114281



Notes: Available to order in full pallets. Bridgewood should incorporate a 1/8" to 1/4" gap between each plank. Plank thicknesses will vary; this is intentional to replicate real planks. Can be laid with all three sizes, or a selection of one or two at any size in a running bond pattern. To achieve the most desired look, Bridgewood is intended to be laid in all three sizes with a 1:1:1 ratio. To calculate number of pieces, Area / 5.17 = how many pieces required. A \$25.00 returnable pallet fee will be charged to any bundle of Bridgewood.

PATTERNS

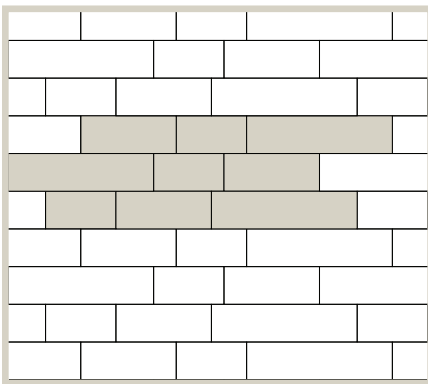

Pieces per 100 sq. ft.

20 pieces: 17 x 10 = 23% of total area

20 pieces: 24 x 10 = 31% of total area

20 pieces: 35 x 10 = 46% of total area

Terra Nova

DESCRIPTION	UNIT						PALLET					PRICE
	SIZE (L X W X H)		FACE AREA		WEIGHT	NO. OF UNITS	NO. OF ROWS	FACE AREA		WEIGHT		
	MM	IN	M2	SQ FT	LB			M2	SQ FT	LB		
Terra Nova	967 x 254 x 51	38.08 x 10.16 x 2	.20	2.2	55	20	-	4.09	44	1100		

COLOURS	ITEM NO.
Tamarack	119909
Mountain Ash	119844



Notes: Terra Nova features 30 unique texture profiles. Available to order in full pallets only. A \$25.00 returnable pallet fee will be charged to any bundle of Terra Nova.

Slabs

Rosetta® Grand Flagstone

DESCRIPTION	UNIT					PALLET					PRICE
	SIZE (L X W X H)		FACE AREA		WEIGHT	NO. OF UNITS	NO. OF ROWS	FACE AREA		WEIGHT	
	MM	IN	M2	SQ FT	LB			M2	SQ FT	LB	
Rosetta® Grand Flagstone	1067 x 965 x 51	42 x 38 x 2	-	-	-	24-32	-	8.36	90	2000	

COLOURS	ITEM NO.
Fon du Lac	104065
Copper Canyon	104069
Pacific Grey	104068

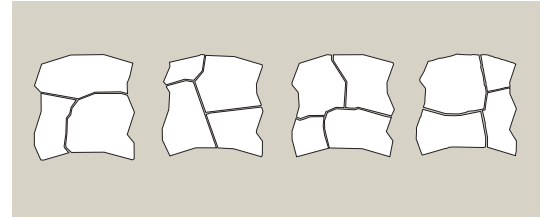

Notes: Measurements (42 x 38 x 2) based on layer configuration. Three to four pieces per layer. Eight layers per pallet, one shape per layer. Available to order in full pallets only. A \$25.00 returnable pallet fee will be charged to any bundle of Grand Flagstone. Recommended installation between 3/16" and 1/4" spacing between units

PATTERNS

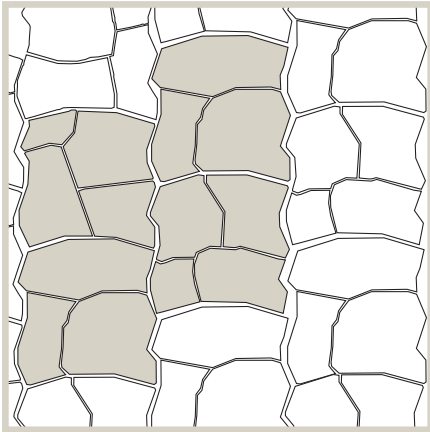

Pattern with All Four Layers

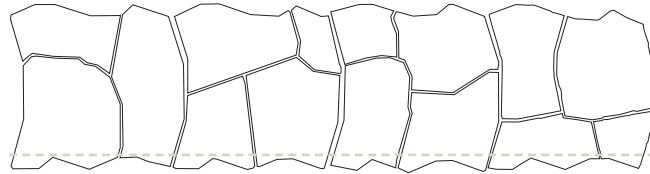

Walkway

Optional: Trim Edges for Straight Lines

Slabs

Rosetta® Dimensional Flagstone

DESCRIPTION	UNIT					PALLET				PRICE	
	SIZE (L X W X H)		FACE AREA		WEIGHT	NO. OF UNITS	NO. OF ROWS	FACE AREA			WEIGHT
	MM	IN	M2	SQ FT	LB			M2	SQ FT		LB
12x6	305 x 152 x 51	12 x 6 x 2	0.05	0.5	11.99	8					
12x12	305 x 305 x 51	12 x 12 x 2	0.09	1	23.97	8					
12x18	305 x 457 x 51	12 x 18 x 2	0.14	1.5	35.95	8					
18x18	457 x 457 x 51	18 x 18 x 2	0.21	2.25	53.96	8			9.10	98	2350
18x24	457 x 610 x 51	18 x 24 x 2	0.28	3	71.94	8					
24x24	610 x 610 x 51	24 x 24 x 2	0.37	4	95.91	8					

COLOURS	ITEM NO.
Fon du Lac	104074
Copper Canyon	104073
Pacific Grey	104072



Notes: Available to order in full pallets only. Pallet contains all slab sizes. A \$25.00 returnable pallet fee will be charged to any bundle of Dimensional Flagstone. A 3/16" or 1/4" gap between each piece is recommended. There are 8 layers per pallet and one of each piece per layer.

PATTERNS

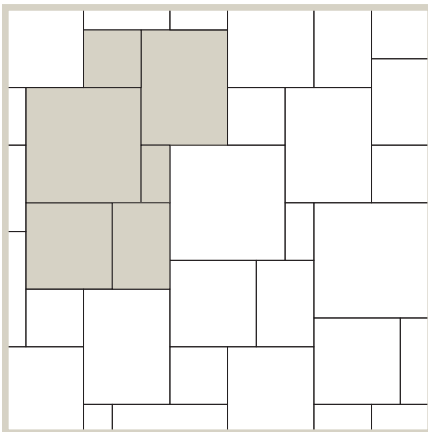

Random Pattern

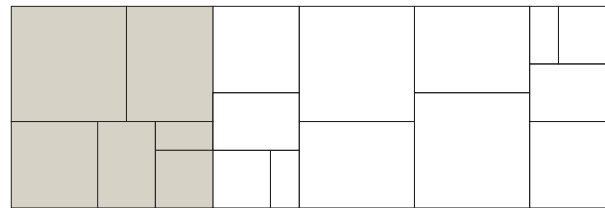

Walkway

Brookside Slab

DESCRIPTION	UNIT					PALLET ROW			PALLET				PRICE	
	SIZE (L X W X H)		FACE AREA		WEIGHT	NO. OF UNITS	FACE AREA		NO. OF UNITS	NO. OF ROWS	FACE AREA			WEIGHT
	MM	IN	M2	SQ FT	LB		M2	SQ FT			M2	SQ FT		LB
16 x 16	400 x 400 x 50	15.75 x 15.75 x 1.97	0.16	1.72	38	-	-	-	42	-	6.71	72.2	1596	
16 x 24	400 x 600 x 50	15.75 x 23.62 x 1.97	0.24	2.58	56	-	-	-	40	-	9.59	103.2	2240	

COLOURS	ITEM NO. 16X16	ITEM NO. 16X24
Charcoal	123705	123709
Sierra Grey	123707	123710
Hazel	123708	123711



Notes: Available to order in full pallets only. A \$25.00 returnable pallet fee will be charged to any bundle of Brookside.

Slabs

Lexington Tile

DESCRIPTION	UNIT					PALLET ROW			PALLET				PRICE	
	SIZE (L X W X H)		FACE AREA		WEIGHT	NO. OF UNITS	FACE AREA		NO. OF UNITS	NO. OF ROWS	FACE AREA			WEIGHT
	MM	IN	M2	SQ FT	LB		M2	SQ FT			M2	SQ FT		LB
16 x 16	400 x 400 x 50	15.75 x 15.75 x 1.97	0.16	1.72	38	-	-	-	42	-	6.71	72.2	1596	
16 x 24	400 x 600 x 50	15.75 x 23.62 x 1.97	0.24	2.58	56	-	-	-	40	-	9.59	103.2	2240	

COLOURS	ITEM NO. 16X16	ITEM NO. 16X24
Sandstone	123714	123717
Sterling	123712	123715
Flint	123713	123716

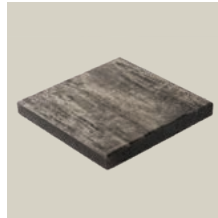

Notes: Available to order in full pallets only. A \$25.00 returnable pallet fee will be charged to any bundle of Lexington Tile.

PATTERNS

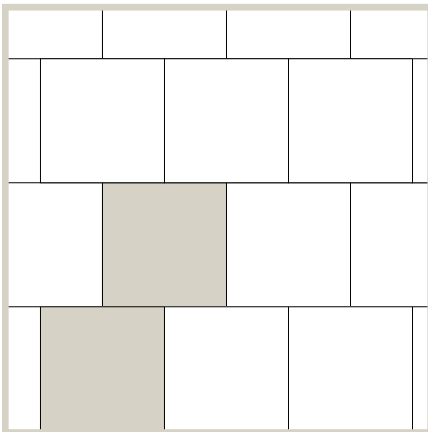

Running Bond 1

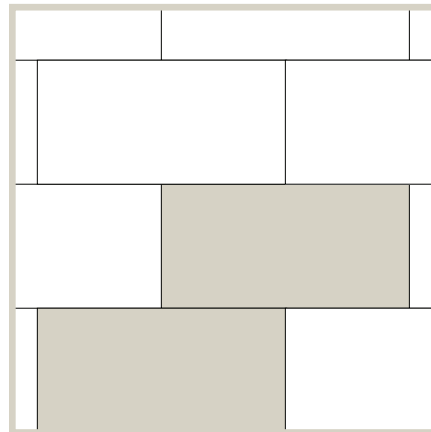

Running Bond 2

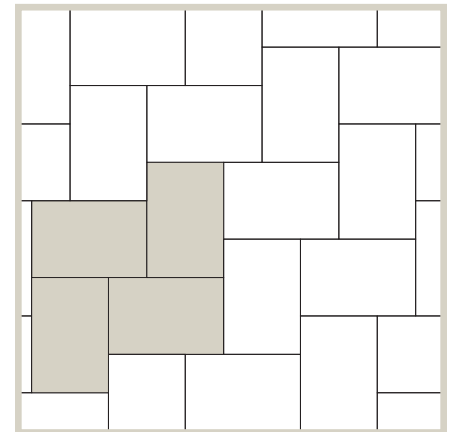

Herringbone

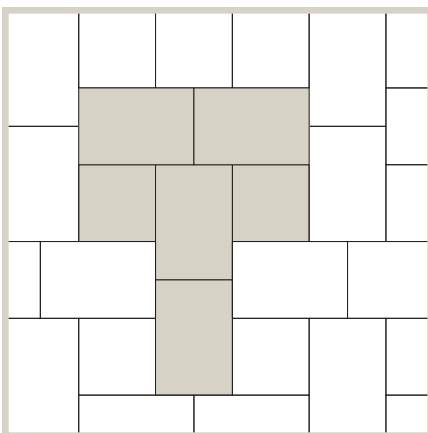

Pattern

Pieces per 100 sq. ft.

15 pieces: 16 x 16 = 25% of total area

29 pieces: 16 x 24 = 75% of total area

Slabs

Diamondface

DESCRIPTION	UNIT					PALLET					PRICE	
	SIZE (L X W X H)		FACE AREA		WEIGHT	NO. OF UNITS	NO. OF ROWS	FACE AREA		WEIGHT		
	MM	IN	M2	SQ FT	LB			M2	SQ FT	LB		
18x18	457 x 457 x 38.1		18 x 18 x 1.5		.21	2.25	41	25	-	5.23	56.25	1025
24x24	610 x 610 x 44		24 x 24 x 1.75		.37	4	90	25	-	9.29	100	2250
24x30	610 x 762 x 44		24 x 30 x 1.75		.46	5	115	25	-	11.61	125	2875

COLOURS	ITEM NO. 18X18	ITEM NO. 24X24	ITEM NO. 24X30
Natural	102542	102557	102568

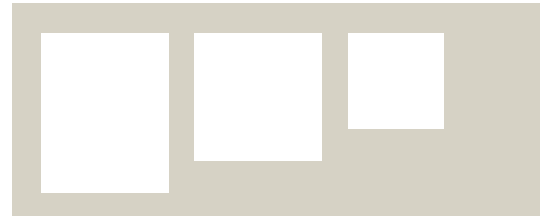
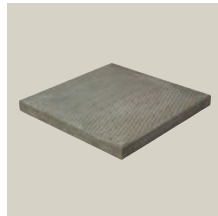

Notes: Available to order in full bundles only. Two (2) bundles or 50 pieces of the 18 x 18 fit on a single returnable pallet. A \$25.00 returnable pallet fee will be charged to any bundle of Diamondface.

Stepping Stones

DESCRIPTION	UNIT					PALLET					PRICE	
	SIZE (L X W X H)		FACE AREA		WEIGHT	NO. OF UNITS	NO. OF ROWS	FACE AREA		WEIGHT		
	MM	IN	M2	SQ FT	LB			M2	SQ FT	LB		
Square	305 x 305 x 51		12 x 12 x 2		.09	1	24	90	3	8.36	90	2160

COLOURS	ITEM NO. SQUARE
Natural	102508
Charcoal	102523
Desert Buff	102535



Notes: Sold in full bundles only. A \$25.00 returnable pallet fee will be charged to any bundle of Stepping Stone. Custom order minimum quantity is 1000 sq ft. Contact your local Barkman sales representative for further details.

Footing Pads

DESCRIPTION	UNIT					PALLET					PRICE	
	SIZE (L X W X H)		FACE AREA		WEIGHT	NO. OF UNITS	NO. OF ROWS	FACE AREA		WEIGHT		
	MM	IN	M2	SQ FT	LB			M2	SQ FT	LB		
12x12x4	305 x 305 x 102		12 x 12 x 4		-	-	49	60	-	-	-	2940
18x18x4	457 x 457 x 102		18 x 18 x 4		-	-	113	24	-	-	-	2712
18x18x6	457 x 457 x 152		18 x 18 x 6		-	-	164	20	-	-	-	3280
24x24x6	610 x 610 x 152		24 x 24 x 6		-	-	290	8	-	-	-	2320

COLOURS	ITEM NO. 12X12X4	ITEM NO. 18X18X4	ITEM NO. 18X18X6	ITEM NO. 24X24X6
Natural	105895	105899	105900	105906

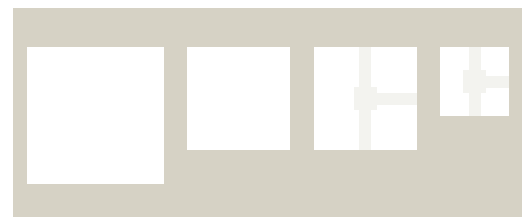

Notes: Indent for post T slot on 12" x 12" x 4" and 18" x 18" x 4" is 1". Available to order in full pallets only. A \$25.00 returnable pallet fee will be charged to any bundle of Footing Pads

Walls



Barkman's wide selection of retaining walls are as versatile as they are stylish. Build small planter boxes and garden walls with Quarry Stone or our new Bridgewood Wall. Erect large commercial retaining walls quickly with Rosetta® Outcropping. Whatever your project, Barkman has the wall system for you.

Walls

Bridgewood Wall (NEW)

DESCRIPTION	UNIT					PALLET				PRICE
	SIZE (H X W X D)		FACE AREA		WEIGHT	NO. OF UNITS	FACE AREA		WEIGHT	
	MM	IN	M2	SQ FT	LB		M2	SQ FT	LB	
Bridgewood Wall	152 x 1067 x 203	6 x 42 x 8	0.16	1.75	171	15	2.44	26.25	2565	

COLOURS	ITEM NO.
Cedar Brown	138331
Weathered Grey	138332

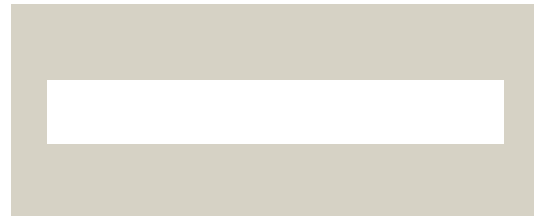
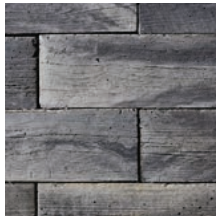

StackStone®

DESCRIPTION	UNIT					PALLET ROW				PALLET				PRICE
	SIZE (H X W X D)		FACE AREA		WEIGHT	NO. OF UNITS	FACE AREA		NO. OF UNITS	NO. OF ROWS	FACE AREA		WEIGHT	
	MM	IN	M2	SQ FT	LB		M2	SQ FT			M2	SQ FT	LB	
Standard	102 x 203/152 x 203	4 x 8/6 x 8	.02	.20	18	24	.45	4.8	120	5	2.23	24	2160	
Coping	102 x 203/152 x 203	4 x 8/6 x 8	.02	.20	18	24	.45	4.8	120	5	2.23	24	2160	
Advanced Corner	102 x 280/203 x 203	4 x 11/8 x 8	-	-	27	12	-	-	48	4	-	-	1296	

COLOURS	ITEM NO. STANDARD	ITEM NO. COPING	ITEM NO. CORNER
Charcoal	103957	103960	104261
Desert Buff	103969	103972	104265
Antique Brown	103853	103852	104248
Sierra Grey	103963	103964	104263



Notes: To calculate pieces required, multiply the wall length, in feet, by 1.72. This will give you the number of pieces required per layer. Then multiply this by the number of layers to determine total quantity required. Please note that 1.72 is the multiplier used for both the standard and coping units. It's recommended to go a maximum of 2' height. Minimum inside diameter of 42" (23 pieces). A \$25.00 returnable pallet fee will be charged to any bundle of StackStone.

RomanStack®

DESCRIPTION	UNIT					PALLET ROW				PALLET				PRICE
	SIZE (H X W X D)		FACE AREA		WEIGHT	NO. OF UNITS	FACE AREA		NO. OF UNITS	NO. OF ROWS	FACE AREA		WEIGHT	
	MM	IN	M2	SQ FT	LB		M2	SQ FT			M2	SQ FT	LB	
Standard	102 x 203/152 x 203	4 x 8/6 x 8	.02	.20	18	24	.45	4.8	120	5	2.23	24	2160	
Coping	102 x 203/152 x 203	4 x 8/6 x 8	.02	.20	18	24	.45	4.8	120	5	2.23	24	2160	
Advanced Corner	102 x 280/203 x 203	4 x 11/8 x 8	-	-	27	12	-	-	48	4	-	-	1296	

COLOURS	ITEM NO. STANDARD	ITEM NO. COPING	ITEM NO. CORNER
Charcoal	103901	103902	104262
Desert Buff	103924	103925	104266
Antique Brown	103892	103891	104249
Sierra Grey	103919	103920	104264



Notes: To calculate pieces required, multiply the wall length, in feet, by 1.72. This will give you the number of pieces required per layer. Then multiply this by the number of layers to determine total quantity required. Please note that 1.72 is the multiplier used for both the standard and coping units. It's recommended to go a maximum of 2' height. Minimum inside diameter of 42" (23 pieces). A \$25.00 returnable pallet fee will be charged to any bundle of RomanStack.

Walls

Quarry Stone

DESCRIPTION	UNIT					PALLET ROW				PALLET				PRICE
	SIZE (H X W X D)		FACE AREA		WEIGHT	NO. OF UNITS	FACE AREA		NO. OF UNITS	NO. OF ROWS	FACE AREA		WEIGHT	
	MM	IN	M2	SQ FT	LB		M2	SQ FT			M2	SQ FT	LB	
Standard	102 x 305 x 203	4 x 12 x 8	.03	.33	33	24	.74	7.92	96	4	2.94	31.68	3168	
12" Radius	102 x 305/273 x 203	4 x 12/10.75 x 8	.03	.33	31	24	.74	7.92	96	4	2.94	31.68	2976	
Untumbled Standard	102 x 305 x 203	4 x 12 x 8	.03	.33	33	24	.72	7.92	72	3	2.16	23.76	2376	

COLOURS	ITEM NO. STANDARD	ITEM NO. 12" RADIUS	UNTUMBLED STANDARD
Charcoal	103789	103799	-
Desert Buff	103796	103802	-
Antique Brown	103793	103801	-
Sierra Grey	103791	103800	-
Ebony	-	-	103576

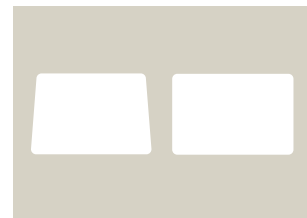

Notes: It is recommended to go a maximum wall height of 2' high. 12" radius / 12" Standard minimum radius 291.5" (40 pieces of each size and half piece of the radius). 12" Radius minimum inside diameter 137.5" (80.5 pieces). A \$25.00 returnable pallet fee will be charged to any bundle of Quarry Stone.

Pisa2®

DESCRIPTION	UNIT					PALLET ROW				PALLET				PRICE
	SIZE (H X W X D)		FACE AREA		WEIGHT	NO. OF UNITS	FACE AREA		NO. OF UNITS	NO. OF ROWS	FACE AREA		WEIGHT	
	MM	IN	M2	SQ FT	LB		M2	SQ FT			M2	SQ FT	LB	
Standard	152 x 203 x 305	6 x 8 x 12	.03	.33	40	15	.46	4.95	60	4	1.84	19.80	2400	
12" Corner	152 x 305 x 229	6 x 12 x 9	-	-	54	16	-	-	64	4	-	-	3456	
12" Splitface Coping	102 x 203 x 305	4 x 8 x 12	-	-	30	24	-	-	72	3	-	-	2160	

COLOURS	ITEM NO. STANDARD	ITEM NO. 12" CORNER	ITEM NO. 12" COPING
Charcoal	103671	103745	103865
Antique Brown	103709	103750	103861
Sierra Grey	103689	103749	103874



Notes: To calculate pieces required for standard units, multiply the length of wall, in feet, by 1.5 for the number of pieces per row. Then multiply number of rows for amount of standard pieces. To calculate coping pieces required, multiply the length of wall, in feet, by 1.6 for amount of coping pieces required. 2 out of 12 coping pieces is an end piece. Each bundle of 60 standard has 60 tapered units (30 left and 30 right). Use all lefts and rights on alternate rows. Minimum inside diameter of 192". For coping pieces, half the bundle will have a radius on one side, and the other half will have the opposite radius. A \$25.00 returnable pallet fee will be charged to any bundle of Pisa2.

Walls

RomanPisa®

DESCRIPTION	UNIT					PALLET ROW				PALLET				PRICE
	SIZE (H X W X D)		FACE AREA		WEIGHT	NO. OF UNITS	FACE AREA		NO. OF UNITS	NO. OF ROWS	FACE AREA		WEIGHT	
	MM	IN	M2	SQ FT	LB		M2	SQ FT			M2	SQ FT	LB	
Standard	152 x 203 x 305	6 x 8 x 12	.03	.33	40	15	.46	4.95	60	4	1.84	19.80	2400	
12" Corner	152 x 305 x 229	6 x 12 x 9	-	-	54	16	-	-	64	4	-	-	3456	
12" Roman Coping	102 x 203 x 305	4 x 8 x 12	-	-	30	24	-	-	72	3	-	-	2160	

COLOURS	ITEM NO. STANDARD	ITEM NO. 12" CORNER	ITEM NO. 12" COPING
Charcoal	103673	103761	103846
Sierra Grey	103690	103767	103849



Notes: To calculate pieces required for standard units, multiply the length of wall, in feet, by 1.5 for the number of pieces per row. Then multiply number of rows for amount of standard pieces. To calculate coping pieces required, multiply the length of wall, in feet, by 1.6 for amount of coping pieces required. 2 out of 12 coping pieces is an end piece. Each bundle of 60 standard has 60 tapered units (30 left and 30 right). Use all lefts and rights on alternate rows. Minimum inside diameter of 192". For coping pieces, half the bundle will have a radius on one side, and the other half will have the opposite radius. A \$25.00 returnable pallet fee will be charged to any bundle of RomanPisa.

Rosetta® Belvedere

DESCRIPTION	UNIT					PALLET ROW				PALLET				PRICE
	SIZE (H X W X D)		FACE AREA		WEIGHT	NO. OF UNITS	FACE AREA		NO. OF UNITS	NO. OF ROWS	FACE AREA		WEIGHT	
	MM	IN	M2	SQ FT	LB		M2	SQ FT			M2	SQ FT	LB	
Wall Pallet	152 x 457/406 x 229	6 x 18/16 x 9	.07	.75	-	-	-	-	12	-	2.51	27	2475	
	152 x 305/254 x 229	6 x 12/10 x 9	.05	.50	-	-	-	-	12	-				
	152 x 152/102 x 229	6 x 6/4 x 9	.02	.25	-	-	-	-	12	-				
	76 x 457/406 x 229	3 x 18/16 x 9	.03	.375	-	-	-	-	12	-				
	76 x 305/254 x 229	3 x 12/10 x 9	.02	.25	-	-	-	-	12	-				
Corner Pallet	76 x 152/102 x 229	3 x 6/4 x 9	.01	.125	-	-	-	-	12	-	2.23	24	1520	
	76 x 381/356 x 229	6 x 15/14 x 9	.06	1	-	-	-	-	16	-				
	76 x 381/356 x 229	3 x 15/14 x 9	.03	.5	-	-	-	-	16	-				

DESCRIPTION	UNIT					PALLET ROW			PALLET			PRICE
	SIZE (H X W X D)		FACE AREA		WEIGHT	NO. OF UNITS	NO. OF UNITS	NO. OF ROWS	LENGTH		WEIGHT	
	MM	IN	M2	SQ FT	LB				M	FT	LB	
Coping Pallet	57 x 457/406 x 260	2.25 x 18/16 x 10.25	-	-	-	-	6	-	10.06	33	775	
	57 x 457/432 x 260	2.25 x 18/17 x 10.25	-	-	-	-	6	-				
	57 x 305/254 x 260	2.25 x 12/10 x 10.25	-	-	-	-	12	-				
	57 x 152/102 x 260	2.25 x 6/4 x 10.25	-	-	-	-	12	-				

COLOURS	ITEM NO. WALL	ITEM NO. CORNER	ITEM NO. COPING
Fon du Lac	104038	104045	104049
Copper Canyon	104040	104047	104051
Pacific Grey	104041	104048	104052



Notes: Recommended maximum wall height is 2'. Available to order in full pallets only. A \$25.00 returnable pallet fee will be charged to any bundle of Belvedere. Belvedere pieces are tapered.

Walls

Rosetta® Dimensional Wall

DESCRIPTION	UNIT					PALLET ROW			PALLET				PRICE	
	SIZE (H X W X D)		FACE AREA		WEIGHT	NO. OF UNITS	FACE AREA		NO. OF UNITS	NO. OF ROWS	FACE AREA			WEIGHT
	MM	IN	M2	SQ FT	LB		M2	SQ FT			M2	SQ FT		LB
Straight	102 x 305 x 203	4 x 12 x 8	.03	.33	28	-	-	-	75	-	2.32	25	2100	
Wedge	102 x 305/229 x 203	4 x 12/9 x 8	.02	.26	22	-	-	-	75	-	2.32	25	1650	

DESCRIPTION	UNIT					PALLET ROW			PALLET				PRICE	
	SIZE (H X W X D)		FACE AREA		WEIGHT	NO. OF UNITS	LENGTH		NO. OF UNITS	NO. OF ROWS	LENGTH			WEIGHT
	MM	IN	M2	SQ FT	LB		M	FT			M	FT		LB
Coping	64 x 610 x 318	2.50 x 24 x 12.50	-	-	-	-	-	-	9	-	-	-	-	
	64 x 457 x 318	2.50 x 18 x 12.50	-	-	-	-	-	-	6	-	9.6	31	975	
	64 x 483 x 318	2.50 x 19 x 12.50	-	-	-	-	-	-	3	-	-	-	-	

COLOURS	ITEM NO. WALL	ITEM NO. WEDGE	ITEM NO. COPING
Fon du Lac	104076	104079	104082
Copper Canyon	104075	104078	104081
Pacific Grey	104077	104080	104083



Notes: Recommended maximum wall height is 2'. Available to order in full pallets only. A \$25.00 returnable pallet fee will be charged in any bundle of Dimensional Wall.

Rosetta® Kodah

DESCRIPTION	UNIT					PALLET ROW			PALLET				PRICE	
	SIZE (H X W X D)		FACE AREA		WEIGHT	NO. OF UNITS	FACE AREA		NO. OF UNITS	NO. OF ROWS	FACE AREA			WEIGHT
	MM	IN	M2	SQ FT	LB		M2	SQ FT			M2	SQ FT		LB
Wall Pallet	152 x 305 x 267	6 x 12 x 10.5	.05	.5	57	3	-	-	3	-	-	-	-	
	152 x 533 x 267	6 x 21 x 10.5	.08	.875	100	6	-	-	6	3	1.95	21	2400	
	152 x 762 x 267	6 x 30 x 10.5	.12	1.25	142	3	-	-	3	-	-	-	-	
	152 x 1067 x 267	6 x 42 x 10.5	1.6	1.75	200	6	-	-	6	-	-	-	-	
Corner Pallet	152 x 533 x 267	6 x 21 x 10.5	.12	1.34	100	16	-	-	16	2	1.95	21	1600	

COLOURS	ITEM NO. WALL	ITEM NO. CORNER
Fon du Lac	118368	118369
Copper Canyon	118458	118459
Pacific Grey	118460	118461



Notes: Available to order in full pallets only. A \$25.00 returnable pallet fee will be charged to any bundle of Rosetta Kodah. Kodah pieces are tapered. Minimum 8.5' radius.

Walls

Rosetta® Outcropping

DESCRIPTION	UNIT					PALLET ROW				PALLET				PRICE
	SIZE (H X W X D)		FACE AREA		WEIGHT	NO. OF UNITS	FACE AREA		NO. OF UNITS	NO. OF ROWS	FACE AREA		WEIGHT	
	MM	IN	M2	SQ FT	LB		M2	SQ FT			M2	SQ FT	LB	
Pallet A	305 x 1067 x 610/508	12 x 42 x 24/20												
	305 x 1219 x 610/508	12 x 48 x 24/20	-	-	-	-	-	-	4	-	1.67	18	3865	
	305 x 1524 x 610/508	12 x 60 x 24/20												
	305 x 1676 x 610/508	12 x 66 x 24/20												
Pallet B	152 x 610 x 610/508	6 x 24 x 24/20												
	152 x 914 x 610/508	6 x 36 x 24/20												
	152 x 1219 x 610/508	6 x 48 x 24/20	-	-	-	-	-	-	6	-	1.67	18	3951	
	305 x 914 x 610/508	12 x 36 x 24/20												
	305 x 1372 x 610/508	12 x 54 x 24/20												
Pallet C	305 x 1829 x 610/508	12 x 72 x 24/20												
	152 x 610 x 610/508	6 x 24 x 24/20												
	152 x 914 x 610/508	6 x 36 x 24/20							4		1.67	18	3889	
	610 x 1219 x 610/508	24 x 48 x 24/20												
Pallet D Freestanding*	457 x 1524 x 610/508	18 x 60 x 24/20												
	305 x 1524 x 762	12 x 60 x 30	-	-	-	-	-	-	3	-	1.02	11	3150	
	305 x 1219 x 762	12 x 48 x 30												
Pallet E Freestanding*	152 x 1219 x 762	6 x 48 x 30												
	305 x 1829 x 762	12 x 72 x 30	-	-	-	-	-	-	3	-	.98	10.5	3500	
	305 x 914 x 762	12 x 36 x 30												
Corner	152 x 914 x 762	6 x 36 x 30												
	305 x 1219 x 737	12 x 48 x 30	.37	6.5	1204	-	-	-	3	-	1.11	12	3612	
Lifting Device (104063)	-	-	-	-	-	-	-	-	1	-	-	-	53	
Paraweb Rosetta Strapping (104064)	-	-	-	-	-	-	-	-	1	-	-	-	28	

COLOURS	ITEM NO. PALLET A	ITEM NO. PALLET B	ITEM NO. PALLET C	ITEM NO. PALLET D	ITEM NO. PALLET E	ITEM NO. CORNER
Fon du Lac	103982	103989	103996	114266	114272	104005
Copper Canyon	103981	103988	103995	114265	114271	104004
Pacific Grey	103983	103990	103997	114267	114273	104006

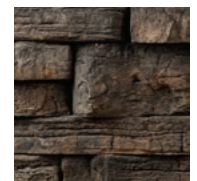

Notes: Product is machine installed. Multiple bundle orders must be ordered in quantities of 2A, 2B, and 1C. Pallet D and E can be ordered separately.
*Can be ordered solid or with hollow core. Available to order in full pallets only. A \$25.00 returnable pallet fee will be charged to any bundle of Outcropping.

Paraweb Rosetta Strapping is sold by the foot. One roll is 384 feet.

Architextures

DESCRIPTION	UNIT					PALLET ROW				PALLET				PRICE
	SIZE (H X W X D)		FACE AREA		WEIGHT	NO. OF UNITS	FACE AREA		NO. OF UNITS	NO. OF ROWS	FACE AREA		WEIGHT	
	MM	IN	M2	SQ FT	LB		M2	SQ FT			M2	SQ FT	LB	
Smooth Standard	150 x 900 x 285	5.9 x 35.43 x 11.22	0.13	1.45	195	-	-	-	15	-	2.02	21.75	2925	
Smooth Closed end Coping	150 x 900 x 285	5.9 x 35.43 x 11.22	0.13	1.45	195	-	-	-	15	-	2.02	21.75	2925	
Smooth Corner	150 x 900 x 285	5.9 x 35.43 x 11.22	0.18	1.95	195	-	-	-	10	-	1.81	19.5	1950	

COLOURS	ITEM NO. STANDARD	ITEM NO. COPING	ITEM NO. CORNER
Flint	134824	137750	134830
Sterling	134825	137752	134831
Ash	134826	137751	134832

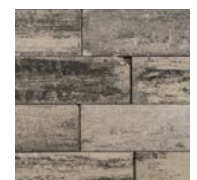

Notes: Every bundle of closed end coping units will come with 3 left end coping units, 3 right end coping units and 9 regular coping units which have open ends. Available to order in full pallets only. A \$25.00 returnable pallet fee will be charged to any bundle of Architextures. This product can be mechanically installed (TSV Manhandle Clamp)

Walls

Keystone Compac III

DESCRIPTION	UNIT					PALLET ROW				PALLET				PRICE
	SIZE (H X W X D)		FACE AREA		WEIGHT	NO. OF UNITS	FACE AREA		NO. OF UNITS	NO. OF ROWS	FACE AREA		WEIGHT	
	MM	IN	M2	SQ FT	LB		M2	SQ FT			M2	SQ FT	LB	
Keystone Compac III Hewnstone Standard	203 x 457 x 305	8 x 18 x 12	0.09	1	73	-	-	-	24	-	2.22	24	1752	
Keystone Compac III Hewnstone Corner	203 x 457.2 x 228.6	8 x 18 x 9	-	-	104	-	-	-	18	-	-	-	1872	
Coping	100 x 450 x 300	3.94 x 17.71 x 11.81	.045	.4845	66	24	10.97	36 lin. ft	48	2	21.95	72 lin. ft	3168	
Fiberglass Alignment Pins	13 x 133	.5 x 5.25	-	-	0.08	-	-	-	100/box	-	-	-	7.9/box	

COLOURS	ITEM NO. STANDARD	ITEM NO. CORNER	ITEM NO. COPING	ITEM NO. FIBERGLASS PINS
Ash	134784	134787	134798	123168
Charcoal	134785	134788	134799	-
Sierra Grey	134786	134789	-	-



Notes: Sold in full pallets only. A \$25.00 returnable pallet fee will be charged to any bundle of Keystone Compac III – Hewnstone. Use 2 fiberglass pins per block to connect. For near vertical batter, place pins in front hole location. For 8.5 degree batter, place pins in back hole location. For 4 degree batter, alternate pin location starting with back pin location on first course, front location on second course and alternating on consecutive layers. Each block needs 2 pins. Alignment pins sold separately.

Durahold

DESCRIPTION	UNIT					PALLET ROW				PALLET				PRICE
	SIZE (H X W X D)		FACE AREA		WEIGHT	NO. OF UNITS	FACE AREA		NO. OF UNITS	NO. OF ROWS	FACE AREA		WEIGHT	
	MM	IN	M2	SQ FT	LB		M2	SQ FT			M2	SQ FT	LB	
Standard	305 x 1829 x 610	12 x 72 x 24	.56	6.00	1740	-	-	-	2	-	-	-	3480	
Coping	305 x 1829 x 610	12 x 72 x 24	.56	6.00	1710	-	-	-	2	-	-	-	3480	
Tie Back	305 x 1829 x 610	12 x 72 x 24	-	-	1529	-	-	-	2	-	-	-	3058	
90 degree Corner Left/Right	305 x 1524 x 610	12 x 60 x 24	-	-	1418	-	-	-	2	-	-	-	2836	
45 degree Corner Left/Right	305 x 1524 x 610	12 x 60 x 24	-	-	1305	-	-	-	2	-	-	-	2610	
1/2 Standard	305 x 914 x 610	12 x 36 x 24	.28	3.00	870	-	-	-	4	-	-	-	3480	
1/2 Coping	305 x 914 x 610	12 x 36 x 24	.28	3.00	870	-	-	-	4	-	-	-	3480	

COLOURS	ITEM NO. STANDARD	ITEM NO. COPING	ITEM NO. TIE BACK	ITEM NO. 90° CORNER RIGHT	ITEM NO. 90° CORNER LEFT	ITEM NO. 1/2 STANDARD	ITEM NO. 45° CORNER RIGHT	ITEM NO. 45° CORNER LEFT	ITEM NO. 45° COPING RIGHT	ITEM NO. 45° COPING LEFT	ITEM NO. 1/2 COPING
Natural	103612	103611	103613	103617	103616	103618	103615	103614	116763	116762	103621



Notes: Half pieces and corner blocks available. Coping is the same as a standard unit but has a flat top. Durahold and Durahold 2 are machine placed.

Walls

Durahold 2

DESCRIPTION	UNIT					PALLET ROW			PALLET				PRICE	
	SIZE (H X W X D)		FACE AREA		WEIGHT	NO. OF UNITS	FACE AREA		NO. OF UNITS	NO. OF ROWS	FACE AREA			WEIGHT
	MM	IN	M2	SQ FT	LB		M2	SQ FT			M2	SQ FT		LB
Standard	305 x 1829 x 356	12 x 72 x 14	.56	6	870	-	-	-	3	-	-	-	2160	
Coping	305 x 1829 x 356	12 x 72 x 14	.56	6	870	-	-	-	3	-	-	-	2160	
1/2 Standard	305 x 914 x 356	12 x 36 x 14	.28	3	435	-	-	-	-	-	-	-	1305	
1/2 Coping	305 x 914 x 356	12 x 36 x 14	.28	3	435	-	-	-	-	-	-	-	1305	

COLOURS	ITEM NO. STANDARD	ITEM NO. COPING	ITEM NO. 1/2 COPING	ITEM NO. 1/2 STANDARD
Natural	103619	103620	113055	113056



Notes: Half pieces and corner blocks available. Coping is the same as a standard unit but has flat top. Durahold and Durahold 2 are machine placed.

Retaining Wall Material Requirements

1) BASE MATERIAL

WALL LENGTH		BASE HEIGHT		BASE WIDTH				MATERIAL REQUIRED
m	x	m	x	m	÷	1	=	m ³
ft	x	ft	x	ft	÷	27	=	cu yd

2) DRAINAGE MATERIAL

WALL LENGTH		BASE HEIGHT						MATERIAL REQUIRED
m	x	m	x	1.33	÷	1	=	m ³
ft	x	ft	x	1.33	÷	27	=	cu yd



Finishing Touches

When it comes to great landscape design, it's the small things that make the biggest difference. Elevate your project with our selection of specialty sands, caps and edgers to make that good project a great one.

Finishing Touches

Pillar Caps

DESCRIPTION	UNIT			PRICE
	SIZE (L X W X H)		WEIGHT	
	MM	IN	LB	
Stone Oasis Chiseled Cap	610 x 610 x 55	24 x 24 x 2	112	
Chiseled Cap with 8" Flat Top	610 x 610 x 102	24 x 24 x 4	131	
Rosetta® Dimensional Column Cap	610 x 610 x 64	24 x 24 x 2.5	125	
Rosetta® Belvedere Column Cap	686 x 686 x 64	27 x 27 x 2.5	155	

COLOURS	ITEM NO. STONE OASIS CHISELED CAP	ITEM NO. CHISELED CAP WITH 8" FLAT TOP	ITEM NO. ROSETTA® DIMENSIONAL COLUMN CAP	ITEM NO. ROSETTA® BELVEDERE COLUMN CAP
Charcoal	-	112855	-	-
Ebony	114780	-	-	-
Fon du Lac	-	-	104085	104053
Copper Canyon	-	-	104084	104055
Pacific Grey	-	-	104086	104056



Villa Edger

DESCRIPTION	UNIT				PALLET ROW				PALLET				PRICE	
	SIZE (L X W X H)		FACE AREA		WEIGHT	NO. OF UNITS	FACE AREA		NO. OF UNITS	NO. OF ROWS	FACE AREA			WEIGHT
	MM	IN	M2	SQ FT	LB		M2	SQ FT			M2	SQ FT		LB
Villa Edger	200 x 71 x 102	11.8 x 2.8 x 4	-	-	12	60	-	-	240	4	-	-	2880	

COLOURS	ITEM NO.
Charcoal	119956
Sierra Grey	119851



Notes: A \$25.00 returnable pallet fee will be charged to any bundle of Villa Edger.

Granite Edger

DESCRIPTION	UNIT				PALLET ROW				PALLET				PRICE	
	SIZE (L X W X H)		FACE AREA		WEIGHT	NO. OF UNITS	FACE AREA		NO. OF UNITS	NO. OF ROWS	FACE AREA			WEIGHT
	MM	IN	M2	SQ FT	LB		M2	SQ FT			M2	SQ FT		LB
Granite Edger	311 x 102 x 102	12.25 x 4 x 4	-	-	14	48	-	-	192	4	-	-	2688	

COLOURS	ITEM NO.
Charcoal	114430
Old Town	114431



Notes: A \$25.00 returnable pallet fee will be charged to any bundle of Granite Edger.

I-Con Edger

DESCRIPTION	UNIT				PALLET ROW				PALLET				PRICE	
	SIZE (L X W X H)		FACE AREA		WEIGHT	NO. OF UNITS	FACE AREA		NO. OF UNITS	NO. OF ROWS	FACE AREA			WEIGHT
	MM	IN	M2	SQ FT	LB		M2	SQ FT			M2	SQ FT		LB
I-con Edger	314 x 92 x 102	12.375 x 3.625 x 4	-	-	15	48	-	-	192	4	-	-	2880	

COLOURS	ITEM NO.
Charcoal	105171
Desert Buff	105175
Sierra Grey	105174



Notes: A \$25.00 returnable pallet fee will be charged to any bundle of I-Con Edger.

Finishing Touches

Polymeric Sand

ITEM NO.	DESCRIPTION	UNIT	PALLET		PRICE
		WEIGHT LB	NO. OF UNITS	WEIGHT LB	
134875	Alliance Polybind Complete G2 Nevada Tan	50	56	2800	
134876	Alliance Polybind Complete G2 Oxford Grey	50	56	2800	
134879	Alliance Polybind Complete G2 Jet Black	50	56	2800	
134878	Alliance Polybind Complete G2 Ivory White	50	56	2800	



Notes: 100mm thick paver with 5mm joint – 27 to 29 sq ft per bag. 80mm thick paver with 5mm joint – 52 to 55 sq ft per bag. 60mm thick paver with 3mm joint – 80–85 sq ft per bag. Please note these numbers on coverage are only approximate due to variability in laying application. No minimum order requirements, can be ordered by bag or by pallet as needed.

Cleaners and Removers

ITEM NO.	DESCRIPTION	UNIT			PRICE
		SIZE	COVERAGE	WEIGHT	
		L	SQ FT	LB	
103043	Efflorescence Cleaner	4	200	10	
112418	Efflorescence Cleaner	18.93	1000	46	
112420	Paver Restorer (241-604)	4	-	10	



Notes: For Efflorescence Cleaner: For removing dirty surfaces, use an 8:1 water:cleaner ratio. For routine maintenance, use a 12:1 water:cleaner ratio. To remove efflorescence, use a 4:1 water:cleaner ratio.

Adhesive

ITEM NO.	DESCRIPTION	UNIT			PRICE
		SIZE	COVERAGE (1/4" BEAD)	WEIGHT	
		ML	FT	LB	
123773	Alliance X-Tra Poly Adhesive 10 oz	295	30	-	
123774	Alliance X-Tra Poly Adhesive 28 oz	828	85	-	



Finishing Touches

Edge Restraint

ITEM NO.	DESCRIPTION	UNIT			BUNDLE		PALLET	PRICE
		SIZE (L X W X H)		WEIGHT	NO. OF	WEIGHT	NO. OF	
		MM	IN	LB	UNITS	LB	UNITS	
112541	Snapedge	2438 x 73 x 44	96 x 2.875 x 1.75	-	24	-	672	
103165	Spikes (Sold in full boxes only)	254 (length)	10 (length)	.33	150	50	-	



Landscaping Materials

ITEM NO.	DESCRIPTION	UNIT			PRICE
		SIZE (L X W)		WEIGHT	
		MM	IN	LB	
103147	Geo-Textile 6oz Non Woven*	91400 x 4572	3600 x 180	220	
133567	Geo Grid 5XT	45720 x 3658	1800 x 144	130	
133673	Geo Grid 10XT	60960 x 3658	2400 x 144	277	
123777	Alliance Gator Base (10 units per package)	902 x 597	35.5 x 23.5	1.32	



Notes: *Geo-textile is a water permeable barrier between the original soil and the clear gravel backfill in the immediate 12" behind the wall. Sold in full rolls only.

Installation Tools

ITEM NO.	DESCRIPTION	UNIT		PRICE
		DIMENSIONS	WEIGHT LB	
106233	Pallet Safety Rail	L x W x H: 610 x 610 x 508 mm/24 x 24 x 20 in	12	
103144	Pave Mark	L x W x H: 660 x 117 x 98/26 x 4.625 x 3.875	-	
103145	Paver Splitter/Guillotine	Cutting Length: 121-10 x 330 mm/4.75-.375 x 13 in	150	
103141	Paver Adjuster	W x H: 362 x 991 mm/14.25 x 39 in	4	
103142	Paver Adjuster Blades	W x H: 32 x 70 mm/1.25 x 2.75 in	-	
103131	Paver Cart	Clamping Width: 584 x 1060mm/23 x 41.75 in	150	
103139	Paver Extractor	Height: 940 mm/37 in	11	
103140	Paver Extractor Blades	L x H: 32 x 70 mm/1.25 x 2.75 in	-	
103164	Paver Saver Uni Mat	L x W: 762 x 559 mm/30 x 22 in	22	
102834	Slab Lifting Device	Opens: 254-479mm/10-18.875 in	4	
133869	TSV Manhandle Clamp	Opening Range 2"-25" 5-64 cm (lifting capacity of 550 lbs)	50	



Notes: Price fluctuates with US currency valuation, please contact Barkman for a quote.

Installation Recommendations

- ✓ Yes
- ✗ No
- Optional

LAYING PATTERNS	PEDESTRIAN TRAFFIC	VEHICULAR TRAFFIC	EDGE RESTRAINTS	BEDDING SAND (25 MM/1 IN)	SPACERS REQUIRED	JOINT SAND	ALLIANCE POLYBIND COMPLETE G2 SAND	COMPACT AFTER INSTALL	COMPACT WITH SAVER MAT	COMPACT AT HALF SPEED
-----------------	--------------------	-------------------	-----------------	---------------------------	------------------	------------	------------------------------------	-----------------------	------------------------	-----------------------

SLABS

Arborwood	4	✓	✗	○	✓	✗	✓	○	✗	
Lexington Tile	4	✓	✗	○	✓	✗	✗	✗	✗	
Brookside Slab	4	✓	✗	○	✓	✗	✗	✗	✗	
Bridgewood	1	✓	✗	○	✓	✓	○	○	✗	
Rosetta® Grand Flagstone	1	✓	✗	○	✓	✗	○	○	✗	
Rosetta® Dimensional Flagstone	2	✓	✗	○	✓	✗	○	○	✗	
Diamondface	1	✓	✗	○	✓	✗	✗	✗	✗	
Stepping Stone	1	✓	✗	○	✓	✗	✗	✗	✗	
Terra Nova	1	✓	✗	○	✓	✓	✗	✓	✗	

PAVERS (50 MM/2 IN)

Villa	3	✓	✗	✓	✓	✗	✗	✓	✓	○	✓
-------	---	---	---	---	---	---	---	---	---	---	---

PAVERS (60 MM/2.36 IN)

Broadway 65mm	10	✓	✗	✓	✓	✗	✓	○	✓	○	✓
Heartland	1	✓	✗	✓	✓	✗	✗	✓	✓	✓	✓
Flagstone	1	✓	✗	✓	✓	✗	✗	✓	✓	✓	✓
Verano	2	✓	✓	✓	✓	✗	✓	○	✓	○	
Holland 8CM	6	✓	✓	✓	✓	✗	✓	○	✓	○	
Roman	3	✓	✓	✓	✓	✗	✓	○	✓	✗	

PAVERS (80 MM/3.15 IN)

Cobble	1	✓	✓	✓	✓	✗	✓	○	✓	✓	
Holland	6	✓	✓	✓	✓	✗	✓	○	✓	○	
Boardwalk	1	✓	✓	✓	✓	✗	✓	○	✓	✓	
Navarro	1	✓	✓	✓	✓	✗	✓	○	✓	✓	
Mesa Flagstone	1	✓	✓	✓	✓	✗	✗	✓	✓	✓	✓

PAVERS (100 MM/3.94 IN)

Broadway 100mm	9	✓	✓	✓	✓	✗	✓	✓	✓	○	
----------------	---	---	---	---	---	---	---	---	---	---	--

Note: *Alliance Polybind Complete G2 sand recommended for commercial/high traffic areas.

Colours

	NATURAL	CHARCOAL	ANTIQU BROWN	SIERRA GREY	DESERT BUFF	EBONY	OLD TOWN	SHORELINE SLATE	AUTUMN BROWN	TAMARACK	MOUNTAIN ASH	STERLING	CEDAR BROWN	WEATHERED GREY	FON DU LAC	COPPER CANYON	PACIFIC GREY	HAZEL	FLINT	SANDSTONE	KODIAK BROWN	TIMBER WOLF GREY	PERFETTO REGENCY WHITE	PERFETTO COSMO BLACK
PAVERS																								
Villa		●		●																				
Broadway 65mm/100mm	●	●										●											●	●
Flagstone			●	●			●																	
Heartland								Custom Order Colours																
Verano		●	●	●			●																	
Holland	●	●	●	●	●				●															
Roman		●	●	●	●		●																	
Roman Circle		●	●	●	●		●																	
Bullnose		●																						
Roman Bullnose		●																						
Holland 8cm	●	●																						
Boardwalk								●																
Navarro			●	●		●																		
Cobble			●			●																		
Holland Eco								Custom Order Colours																
Colonial Eco								Custom Order Colours																
Turfstone Eco	●																							
Villa Edger		●		●																				
I-con Edger		●		●	●																			
Granite Edger		●					●																	
SLABS																								
Arborwood																						●	●	
Terra Nova										●	●													
Rosetta® Grand Flagstone																●	●	●						
Rosetta® Dimensional Flagstone																●	●	●						
Bridgewood													●	●										
Brookside Slab			●		●															●				
Lexington Tile												●									●	●		
Diamondface		●																						
Stepping Stone Square		●	●			●																		

Colours

NATURAL	CHARCOAL	ANTIQUE BROWN	SIERRA GREY	DESERT BUFF	EBONY	AUTUMN BROWN	STERLING	FON DU LAC	COPPER CANYON	PACIFIC GREY	FLINT	ASH	CEDAR BROWN	WEATHERED GREY
---------	----------	---------------	-------------	-------------	-------	--------------	----------	------------	---------------	--------------	-------	-----	-------------	----------------

WALLS

	NATURAL	CHARCOAL	ANTIQUE BROWN	SIERRA GREY	DESERT BUFF	EBONY	AUTUMN BROWN	STERLING	FON DU LAC	COPPER CANYON	PACIFIC GREY	FLINT	ASH	CEDAR BROWN	WEATHERED GREY
Bridgewood Wall														●	●
StackStone®		●	●	●	●										
RomanStack®		●	●	●	●										
Pisa2®		●	●	●											
Splitface Coping		●	●	●											
RomanPisa®		●		●											
Roman Coping		●		●											
Quarry Stone		●	●	●	●										
Untumbled Quarry Stone						●									
Rosetta® Belvedere									●	●	●				
Rosetta® Dimensional Wall									●	●	●				
Rosetta® Outcropping									●	●	●				
Rosetta® Kodah									●	●	●				
Architextures								●				●	●		
Keystone Compac III – Hewnstone		●		●									●		
Durahold	●														
Durahold 2	●														

Landscape Kits



Landscape kits offer a cost effective way to turn any backyard into something special without custom concrete work. In an afternoon or less, you could build a complete kit from our collection of bars, pillars, firepits, patios and Harvest Grove Outdoor Kitchens. Modular in design and timeless in their appeal, Barkman kits offer the easy choice to elevate your backyard ambitions.

Kits

Stone Oasis Fireplace

KIT	SPECIFICATIONS		NO. OF SKIDS	PALLETS						INCLUDES	PRICE
	ASSEMBLED SIZE (H X W X D)			WEIGHT (LB)							
	MM	IN		1	2	3	4	TOTAL	CHARGED		
Fireplace	2616 x 1321 x 1016	103 x 52 x 40	4	3064	2998	1320	683	8065	3	Quarry Stone, Ebony accents, fire brick, arch, mantle, recess panel, roof, fire brick, fireplace caps, raincap, plastic and steel shims, adhesive, gloves, instructions	
Wood Storage	889 x 1016 x 914	35 x 40 x 36	1	2359				2359	2	Quarry Stone, Ebony counter tops, shims, adhesive, gloves, instructions	
Compact Fireplace	1981 x 1118 x 1016	78 x 44 x 40	3	3036	2176	594		5806	3	Quarry Stone, fire brick, hearth, cap, mantle, spark arrester, shims, high heat sealant, adhesive, instructions, gloves	
Compact Fireplace Wood Storage	965.2 x 813 x 711	38 x 32 x 28	1	2000					2	Quarry Stone, Ebony counter tops, shims, adhesive, gloves, instructions	
Raincap	257 x 476 x 686	10.13 x 18.75 x 27	1	10				10	-	Raincap	

COLOURS	ITEM NO. FIREPLACE	ITEM NO. WOOD STORAGE	ITEM NO. COMPACT FIREPLACE	ITEM NO. COMPACT FIREPLACE WOOD STORAGE	RAINCAP
Sierra Grey/ Ebony Accent	134517	113461	119339	120519	134752

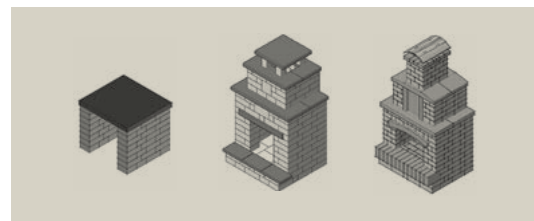

Notes: Colours may vary between various components.

Stone Oasis Curved Bar

KIT	SPECIFICATIONS		NO. OF SKIDS	PALLETS		INCLUDES	PRICE
	ASSEMBLED SIZE (H X W X D)			WEIGHT	TOTAL CHARGED		
	MM	IN		LB			
Curved Bar	1092 x 2032 x 762	43 x 80 x 30	2	3527	1	Quarry Stone, Polished Granular Countertops, shims, adhesive, gloves, instructions	

COLOURS	ITEM NO.
Sierra Grey/Polished Granular Countertop	118717

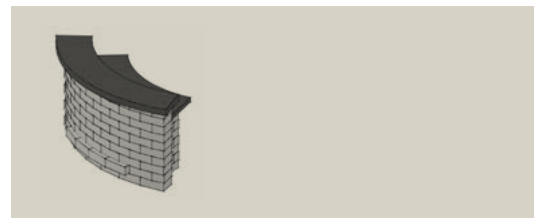

Notes: Although product ships on two skids, customer will only be charged for one \$25.00 returnable Barkman pallet. Colours may vary between various components. For detailed video installation, please visit BarkmanConcrete.com.

Kits

Stone Oasis Circle Patios

KIT	SPECIFICATIONS		PALLETES		INCLUDES	PRICE
	ASSEMBLED SIZE (W X D)		NO. OF PALLETES	WEIGHT LB		
	MM	IN				
Circle	60 x 3734	2.36 x 147	2	3571	Roman Circle pavers, splitface paver accents, polymeric sand, gloves	
Circle Border	60 x 4877	2.36 x 192	1	2293	Roman Circle pavers, splitface paver accents, polymeric sand, gloves	

COLOURS	ITEM NO. CIRCLE	ITEM NO. CIRCLE BORDER
Sierra Grey/Desert Buff Accent	103503*	112410*
Sierra Grey/Ebony Accent	103518	114544
Desert Buff/Charcoal Accent	103504	112608

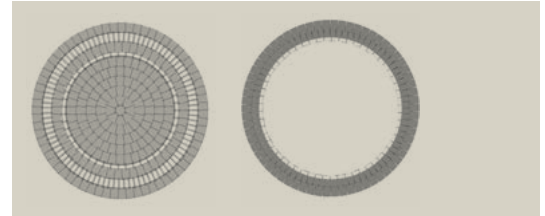

Notes: Sierra Grey option includes either Desert Buff or Ebony accent. Desert Buff colour contains Charcoal accent. For detailed video installation, please visit BarkmanConcrete.com. * While supplies last.

Modern Firepit

KIT	SPECIFICATIONS		PALLETES		INCLUDES	PRICE
	ASSEMBLED SIZE (H X W X D)		NO. OF PALLETES	WEIGHT LB		
	MM	IN				
Square Complete	305 x 711 x 711	12 x 28 x 28 (inside)	1	1190	Untumbled Quarry Stone, gloves, 27" spark arrestor, firepit liner	

COLOURS	ITEM NO.
Ebony	134379
Sierra Grey	137931 (NEW)
Ebony (no liner)	137933
Sierra Grey (no liner)	137932

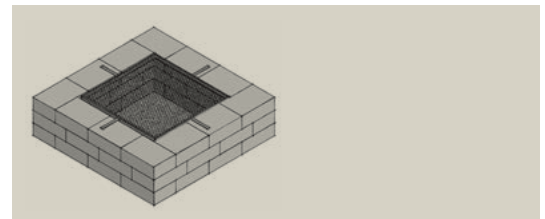

Notes: The Modern Firepit has 3 layers with 12 pieces per layer. Outside dimensions are 44" or 1118 mm.

Kits

Stone Oasis Circle Firepit

KIT	SPECIFICATIONS		PALLETES		INCLUDES	PRICE
	ASSEMBLED SIZE (H X D)		NO. OF PALLETES	WEIGHT LB		
	MM	IN				
Circle Complete	305 x 635 (inside)	12 x 25 (inside)	1	838	StackStone®, gloves, 24" spark arrestor, instructions	
Circle Spark Arrestor (112548)	- x 610	- x 240		5		

COLOURS	ITEM NO.
Charcoal	103520
Desert Buff	103519
Antique Brown	103521
Sierra Grey	103522

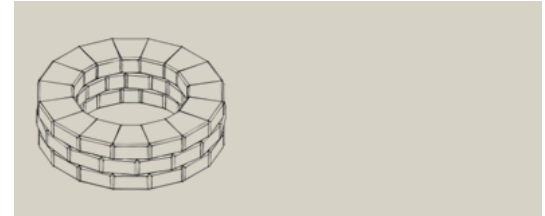

Notes: The Stone Oasis Circle Firepit has three layers with 16 pieces per layer. Outside diameter is 42" or 1067 mm. For detailed video installation, please visit BarkmanConcrete.com.

Stone Oasis Square Firepit

KIT	SPECIFICATIONS		PALLETES		INCLUDES	PRICE
	ASSEMBLED SIZE (H X W X D)		NO. OF PALLETES	WEIGHT LB		
	MM	IN				
Square Complete	305 x 711 x 711	12 x 28 x 28 (inside)	1	1190	Quarry Stone, gloves, 27" spark arrestor	
Square Spark Arrestor (113807)	686 x 686	27 x 27	-	5		
Firepit Liner* (115253)	711 x 711	28 x 28	1	55		

COLOURS	ITEM NO.
Charcoal	113806
Sierra Grey	115753

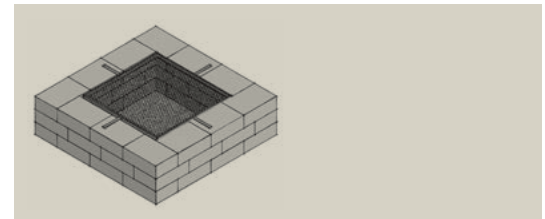

Notes: The Stone Oasis Square Firepit has 3 layers with 12 pieces per layer. Outside dimensions 44" or 1118 mm. *Firepit liner sold separately.

Kits

Rosetta® Firepit Kits

KIT	SPECIFICATIONS		PALLETS		INCLUDES	PRICE
	ASSEMBLED SIZE (H X W X D)		NO. OF PALLETS	WEIGHT LB		
	MM	IN				
Dimensional Square Firepit Complete	305 x 711 x 711	12 x 28 x 28	1	1170	Dimensional Wall, 27" spark arrestor, liner, gloves	
Square Spark Arrestor* (113807)	675 x 675	27 x 27	-	5		
Square Firepit Liner (115253)	711 x 711	28 x 28	1	55		

KIT	SPECIFICATIONS		PALLETS		INCLUDES	PRICE
	ASSEMBLED SIZE (H X D)		NO. OF PALLETS	WEIGHT LB		
	MM	IN				
Belvedere Circle Firepit Complete	381 x 1067 (inside)	15 x 42 (inside)	1	1257	Belvedere, gloves, black steel ring	
Circle Spark Arrestor* (114836)	- x 940	- x 37		12		
Circle Black Steel Ring (103593)	305 x 965	12 x 38	1	45		

COLOURS	ITEM NO. CIRCLE	ITEM NO. SQUARE
Fon du Lac	103507	115347
Copper Canyon	103511	115346
Pacific Grey	103508	115348



Notes: 37" diameter spark arrestor sold separately. For detailed video installation, please visit BarkmanConcrete.com.

Stone Oasis Pillar Kits

KIT	SPECIFICATIONS		PALLETS		INCLUDES	PRICE
	ASSEMBLED SIZE (H X W X D)		NO. OF PALLETS	WEIGHT LB		
	MM	IN				
Stone Oasis Pillar	813 x 508 x 508	32 x 20 x 20	1	1124	Quarry Stone, Ebony accents, pillar cap, adhesive, gloves	

COLOURS	ITEM NO.
Sierra Grey/Ebony Accent	112411

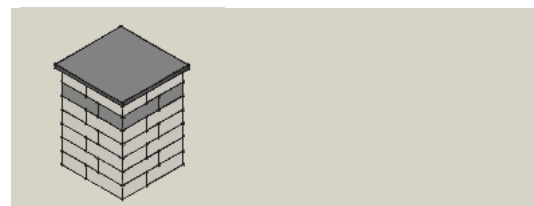

Notes: Colours may vary between components. For detailed video installation, please visit BarkmanConcrete.com.

Rosetta® Pillar Kits

KIT	SPECIFICATIONS		PALLETS		INCLUDES	PRICE
	ASSEMBLED SIZE (H X W X D)		NO. OF PALLETS	WEIGHT LB		
	MM	IN				
Rosetta® Belvedere	914 x 610 x 610	36 x 24 x 24	1	2293	Belvedere, pillar cap, adhesive, gloves	
Rosetta® Dimensional	876 x 508 x 508	34.5 x 20 x 20	1	1051	Dimensional Wall, pillar cap, adhesive, gloves	

COLOURS	ITEM NO. ROSETTA® BELVEDERE	ITEM NO. ROSETTA® DIMENSIONAL
Fon du Lac	103509	115687
Copper Canyon	103512	115686
Pacific Grey	103510	115688



Notes: Colours may vary between components. For detailed video installation, please visit BarkmanConcrete.com.

Kits

Harvest Grove Kitchen Kits

KIT	ITEM NO.	SPECIFICATIONS		NO. OF SKIDS	PALLETS						INCLUDES	PRICE
		ASSEMBLED SIZE (H X W X D)			WEIGHT (LB)							
		MM	IN		1	2	3	4	TOTAL	PALLETS CHARGED		
Pizza Oven	112651	2057 x 1524 x 1626	81 x 60 x 64	4	3219	3175	1764	485	8643	2	Quarry Stone, oven dome and floor, Ebony arches, divider plates, mantle and roof, stainless steel chimney and spark arrestor, cap, pizza peel shims, adhesive, gloves	
Compact Pizza Oven Base	134271	953 x 813 x 749	37.5 x 32 x 29.5	1	1918	-	-	-	1918	1	Quarry Stone, countertop, shims, adhesive, gloves, instructions	
Compact Pizza Oven Dome	135882	1016 x 762 x 749	40 x 30 x 29.5	1	115	-	-	-	115	1	Pizza Oven unit, pizza peel	
Napoleon BBQ Grill with Polished Granular Countertop (natural gas)	135884	1308 x 1524 x 711	51.5 x 60 x 28	2	2822	419	-	-	3241	3	Quarry Stone, 4 burner grill, stainless steel vent box, tank holder, drawer frame, Ebony Polished Granular Countertops, shims, adhesive, gloves	
Napoleon BBQ Grill with Polished Granular Countertop (propane)	134740	1308 x 1524 x 711	51.5 x 60 x 28	2	2822	419	-	-	3241	3	Quarry Stone, 4 burner grill, stainless steel vent box, tank holder, drawer frame, Ebony Polished Granular Countertops, shims, adhesive, gloves	
Side Burner with Polished Granular Countertop	117977	953 x 914 x 711	37.5 x 36 x 28	1	2500	-	-	-	2500	3	Quarry Stone, stainless steel vent box and slide in double side burner, propane line splitter kit, Ebony Polished Granular Countertop, shims, adhesive, gloves	
Prep Station with Waste Receptacle and Polished Granular Countertop	117904	953 x 914 x 711	37.5 x 36 x 28	2	2024	198	-	-	2300	3	Quarry Stone, stainless steel waste receptacle frame and drawer, waste chute, cutting board, Ebony Polished Granular Countertop, shims, adhesive, gloves	
Bar with Fridge and Polished Granular Countertop	117975	953 x 1219 x 711	37.5 x 48 x 28	2	2508	176	-	-	2850	3	Quarry Stone, stainless steel outdoor rated fridge, Ebony Polished Granular Countertop, shims, adhesive, gloves, instructions	
Bar with Fridge and Extended Countertop	120472	953 x 1219 x 965	37.5 x 48 x 38	2	2608	176	-	-	2950	3	Quarry Stone, stainless steel outdoor rated fridge, Ebony Polished Granular Extended Countertop, shims, adhesive, gloves, instructions	
Extended Bar Counter	120251	953 x 1219 x 965	37.5 x 48 x 38	1	3120	-	-	-	3120	3	Quarry Stone, Ebony Polished Granular Extended Countertop, shims, adhesive, gloves, instructions	
Bar Counter with Polished Granular Countertop	117973	953 x 1219 x 711	37.5 x 48 x 28	1	3020	-	-	-	3020	3	Quarry Stone, Ebony Polished Granular Countertop, shims, adhesive, gloves, instructions	
Corner Unit with Polished Granular Countertop	117898	953 x 711 x 711	37.5 x 28 x 28	1	2150	-	-	-	2150	3	Quarry Stone, Ebony Polished Granular Countertop, shims, adhesive, gloves, instructions	
Right Or Left Corner Unit with Extended Countertop	120246 R 120243 L	953 x 711 x 965	37.5 x 28 x 38	1	2250	-	-	-	2250	3	Quarry Stone, Ebony Polished Granular Extended Countertop, shims, adhesive, gloves, instructions	
Right Or Left End Unit with Polished Granular Countertop	117971 R 117901 L	953 x 711 x 711	37.5 x 28 x 28	1	2150	-	-	-	2150	3	Quarry Stone, Ebony Polished Granular Countertop, shims, adhesive, gloves, instructions	

Kits

Harvest Grove Kitchen Kits (cont.)

KIT	ITEM NO.	SPECIFICATIONS		NO. OF SKIDS	PALLETS						INCLUDES	PRICE	
		ASSEMBLED SIZE (H X W X D)			WEIGHT (LB)								
		MM	IN		1	2	3	4	TOTAL	PALLETS CHARGED			
Right Or Left End Unit Extended Counter	120553	953 x 711 x 965	37.5 x 28 x 38	1	2250	-	-	-	-	2250	3	Quarry Stone, Ebony Polished Granular Extended Countertop, shims, adhesive, gloves, instructions	

COLOURS

Sierra Grey/Ebony Accent

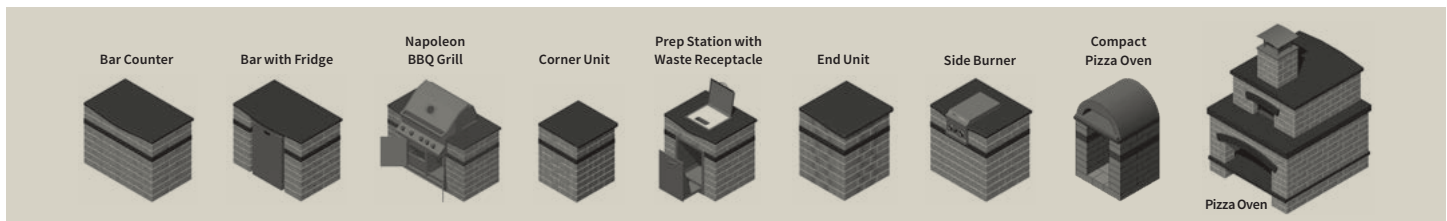

Notes: Polished Granular Countertops have an exposed aggregate and smooth finish. All Harvest Grove Kits with Stainless Steel Components can be ordered without Stainless Steel Components. Product no. 117897 (Sunstone BBQ Grill) sold while supplies last.

Harvest Grove Kitchen Kit Components

KIT COMPONENTS	ITEM NO.	SPECIFICATIONS		NO. OF SKIDS	PALLETS						INCLUDES	PRICE	
		ASSEMBLED SIZE (H X W X D)			WEIGHT (LB)								
		MM	IN		1	2	3	4	TOTAL	PALLETS CHARGED			
Napoleon BBQ Grill (propane)	133987	635 x 826 x 635	25 x 32.5 x 25	1	419					419	1	Napoleon BBQ Grill (propane), instructions	
Napoleon BBQ Grill (natural gas)	135394	635 x 826 x 635	25 x 32.5 x 25	1	419					419	1	Napoleon BBQ Grill (natural gas), instructions	
BBQ Grill Polished Granular Countertop	120337	38 x 1524 x 711	1.5 x 60 x 28	1	110	-	-	-		110	1	Ebony Polished Granular BBQ Grill Countertop, 3-piece countertop	
Side Burner Polished Granular Countertop	117978	38 x 918 x 787	1.5 x 36 x 30	1	110	-	-	-		110	1	Ebony Polished Granular Side Burner Countertop	
Prep Station Polished Granular Countertop	117902	38 x 918 x 787	1.5 x 36 x 31	1	113	-	-	-		113	1	Ebony Polished Granular Prep Station Countertop	
4' Bar Polished Granular Countertop	117974	38 x 1226 x 787	1.5 x 48 x 31	1	190	-	-	-		190	1	Ebony Polished Granular Bar Countertop	
4' Extended Fridge/Bar Countertop	120250	38 x 1226 x 1041	1.5 x 48 x 41	1	259	-	-	-		259	1	Ebony Polished Granular Extended Bar Countertop for both the Fridge Unit and Bar Unit	
Corner Unit Polished Granular Countertop	117899	38 x 749.3 x 749.3	1.5 x 29.5 x 29.5	1	113	-	-	-		113	1	Ebony Polished Granular Corner Countertop	
Right or Left Extended Corner Unit Countertop	120244 L 120247 R	38 x 749.3 x 1003.3	1.5 x 29.5 x 39.5	1	154	-	-	-		154	1	Ebony Polished Granular Extended Corner unit Countertop	
Right or Left End Unit Polished Granular Countertop	117900 L 117972 R	38 x 787.4 x 749.3	1.5 x 31 x 29.5	1	115	-	-	-		115	1	Ebony Polished Granular Right or Left End Unit Countertop	

Kits

Harvest Grove Kitchen Kit Components (cont.)

KIT COMPONENTS	ITEM NO.	SPECIFICATIONS		NO. OF SKIDS	PALLETS						INCLUDES	PRICE
		ASSEMBLED SIZE (H X W X D)			WEIGHT (LB)							
		MM	IN		1	2	3	4	TOTAL	PALLETS CHARGED		
Right or Left Extended End Unit Countertop	120531	38 x 1040 x 749.3	1.5 x 41 x 29.5	1	157	-	-	-	157	1	Ebony Polished Granular Right or Left Extended End Unit Countertop	
*BBQ Grill Natural Gas Conversion Kit	116163	-	-	-	-	-	-	-	10	-	50mm drill bit, gas valve, regulator, instructions	
Side Burner Natural Gas Conversion Kit	116164	-	-	-	-	-	-	-	10	-	50mm drill bit, gas valve, regulator, instructions	
BBQ Cover	116854	-	-	-	-	-	-	-	-	-	BBQ Cover for BBQ Grill Unit	
Side Burner Cover	116855	-	-	-	-	-	-	-	-	-	Side Burner Cover for Side Burner Unit	
Pizza Oven Dome and Floor	120467	1092 x 483 x 965	43 x 19 x 38	1	1342	-	-	-	1342	1	Pizza Oven Dome and Floor	
BBQ Double Door Bottom	115547	517.65 x 755.65 x 508	20.38 x 29.75 x 20	1	61				61	1	BBQ Double Door Bottom	
Waste Receptacle Drawer	115550	686 x 508 x 410	27 x 20 x 16.13	1	40				40	1	Waste Receptacle Drawer	
Bar Fridge	115549	844.55 x 520.7 x 584	33.25 x 20.5 x 23	1	99				99	1	Bar Fridge	
Side Burner	115548	318 x 330 x 572	12.5 x 13 x 22.5	1	32				32	1	Side Burner	
Vent Box	115552	127 x 229	5 x 9		2				2		Vent Box	

Notes: Polished Granular Countertops have an exposed aggregate and smooth finish. *A gas fitter is required to install the BBQ Grill Natural Gas. Colours may vary between various components. Extended Countertops only work in configurations with other Extended Countertops. When ordering the Extended Countertop, determine Left or Right unit by imagining standing behind the bar counter looking out towards the extended countertop section. Example: looking to the right side would entail ordering a right unit Extended Countertop.

Site Furnishings



Add distinctive flair to your next interior or exterior landscaping project with our wide selection of attractive Site Furnishings and Accessories. We have unlimited shapes and colour combinations to choose from, and our simple, yet classic styling makes our furnishings ideal for almost any application.

Site Furnishings

Cast Planter

DESCRIPTION	NATURAL	GREY	CHARCOAL	WHITE	UNIT			PRICE
					SIZE (D X H)		WEIGHT	
					MM	IN	LB	
Round Small	123177	123178	123179	123180	749 x 775	29.5 x 30.5	497	
Round Medium	123023	123181	123182	123183	898 x 927	35.37 x 36.5	735	
Round Large	123104	123184	123185	123186	1048 x 1079	41.25 x 42.5	1019	



DESCRIPTION	NATURAL	GREY	CHARCOAL	WHITE	UNIT			PRICE
					SIZE (L X W X H)		WEIGHT	
					MM	IN	LB	
Square Small	123092	123187	123188	123189	737 x 737 x 771	29 x 29 x 30.37	705	
Square Medium	123022	123190	123191	123192	889 x 889 x 924	35 x 35 x 36.37	1104	
Square Large	123093	123193	123194	123195	1041 x 1041 x 1076	41 x 41 x 42.37	1385	

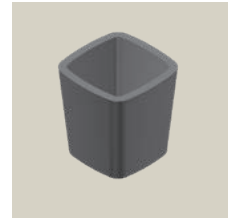

DESCRIPTION	NATURAL	GREY	CHARCOAL	WHITE	UNIT			PRICE
					SIZE (L X W X H)		WEIGHT	
					MM	IN	LB	
Rectangle Small	123084	123196	123197	123198	889 x 428 x 622	35 x 16.87 x 24.5	515	
Rectangle Medium	123020	123199	123200	123201	1194 x 581 x 775	47 x 22.87 x 30.5	900	
Rectangle Large	123085	123202	123203	123204	1499 x 733 x 927	59 x 28.87 x 36.5	1441	

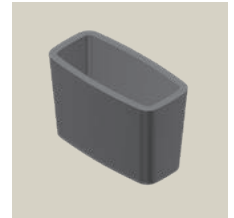

Cast Bench

DESCRIPTION	NATURAL	GREY	CHARCOAL	WHITE	UNIT			PRICE
					SIZE (L X W X H)		WEIGHT	
					MM	IN	LB	
Cast Bench with Unstained Cedar Planks	133821	134810	134811	134812	2286 x 419 x 457	90 x 16.5 x 18	548	
Cast Bench w/ Golden Cedar Stain Cedar Planks	137823	137824	137825	137826	2286 x 419 x 457	90 x 16.5 x 18	548	
Cast Bench w/ Charcoal Stain Cedar Planks	137827	137828	137829	137830	2286 x 419 x 457	90 x 16.5 x 18	548	



Notes: The staining on the cedar is not uniform and will have light and dark areas. See colour chart for available colours. Contact Barkman for more details. Wood finishes available are Natural Cedar, Charcoal and Golden Cedar.

Site Furnishings

Cast Bench with Back (NEW)

DESCRIPTION	NATURAL	GREY	CHARCOAL	WHITE	UNIT			PRICE
					SIZE (L X W X H)		WEIGHT	
					MM	IN	LB	
Cast Bench with Back, Unstained Cedar Planks	127635	127636	127637	127638	2286 x 546.1 x 812.8	90 x 21.5 x 32	638	
Cast Bench w/ Back, Golden Cedar Stain Cedar Planks	127639	127640	127641	127642	2286 x 546.1 x 812.8	90 x 21.5 x 32	638	
Cast Bench w/ Back, Charcoal Stain Cedar Planks	127643	127644	127645	127646	2286 x 546.1 x 812.8	90 x 21.5 x 32	638	



Notes: The staining on the cedar is not uniform and will have light and dark areas. See colour chart for available colours. Contact Barkman for more details. Wood finishes available are Natural Cedar, Charcoal and Golden Cedar. Seat height is 18 inches. Actual backrest height is 32 inches.

Skyline Bench (NEW)

DESCRIPTION	NATURAL	GREY	CHARCOAL	WHITE	UNIT			PRICE
					SIZE (L X W X H)		WEIGHT	
					MM	IN	LB	
Skyline Bench with Charcoal Stain	128540	128542	128544	128546	1828.8 x 444.5 x 498.6	72 x 17.5 x 19.63	398	
Skyline Bench with Provincial Stain	128539	128541	128543	128545	1828.8 x 444.5 x 498.6	72 x 17.5 x 19.63	398	



Notes: The staining on the cedar is not uniform and will have light and dark areas. See colour chart for available colours. Contact Barkman for more details. Available wood stain options are Charcoal and Provincial.

One40Two Bench

DESCRIPTION	NATURAL	GREY	CHARCOAL	WHITE	UNIT			PRICE
					SIZE (L X W X H)		WEIGHT	
					MM	IN	LB	
One40Two Bench w/ Golden Cedar Stain Cedar Planks	134416	137845	134507	137846	2121 x 451 x 457	83.5 x 17.75 x 18	699	
One40Two Bench w/ Charcoal Stain Cedar Planks	137847	137848	137849	137850	2121 x 451 x 457	83.5 x 17.75 x 18	699	



Notes: Staining on the cedar is not uniform and will have light and dark areas. Available wood stain options are Golden Cedar and Charcoal. Seat height is 18 inches. Actual maximum height is 21 inches.

One40Two Bench with Back (NEW)

DESCRIPTION	NATURAL	GREY	CHARCOAL	WHITE	UNIT			PRICE
					SIZE (L X W X H)		WEIGHT	
					MM	IN	LB	
One40Two Bench w/ Golden Cedar Stain Cedar Planks	138286	138285	138287	138284	2121 x 671.58 x 823.98	83.5 x 26.44 x 32.44	748	
One40Two Bench w/ Charcoal Stain Cedar Planks	138290	138289	138291	138288	2121 x 671.58 x 823.98	83.5 x 26.44 x 32.44	748	

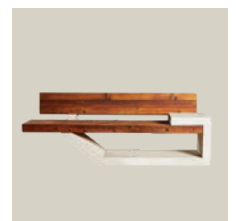

Notes: Staining on the cedar is not uniform and will have light and dark areas. Available wood stain options are Golden Cedar and Charcoal. Seat height is 18 inches. Actual maximum backrest height is 32.44 inches.

Site Furnishings

Park Bench

ITEM NO.	DESCRIPTION	UNIT			PRICE
		SIZE (L X W X H)		WEIGHT	
		MM	IN	LB	
105709	Park Bench (Concrete) Complete	1664 x 610 x 451	65.5 x 24 x 17.75	725	
114691	Park Bench (Concrete) Complete with Indent	1664 x 610 x 451	65.5 x 24 x 17.75	725	
105710	Park Bench (Cedar) Complete	1664 x 610 x 451	65.5 x 24 x 17.75	275	
105703	Park Bench End Left Hand (Pebblestone)	864 x 610 x 70	34 x 24 x 2.75	97	
122235	Park Bench End Right Hand (Pebblestone)	864 x 610 x 70	34 x 24 x 2.75	97	
105713	Park Bench Seat/Back (Cedar) Kit with Hardware	1505 x 406 x 38	59.25 x 16 x 1.5	15	
105686	Park Bench Seat (Concrete)	1505 x 406 x 76	59.25 x 16 x 3	242	
105686	Park Bench Back (Concrete)	1505 x 406 x 76	59.25 x 16 x 3	242	
105715	Sandblast Logo/Signature (Custom order)	-	-	-	

Notes: All cedar components have two coats of Sikkens Dek Base, and one coat of Sikkens Dek #78 natural. On-site assembly required. All cedar planks have the option for Charcoal colour wood. Maximum indent is 3/4" depth. Determine right or left ends when sitting on the bench. For Pebblestone components, a Charcoal colour is available (premium upcharge of 25%).



Plaza Bench

ITEM NO.	DESCRIPTION	UNIT			PRICE
		SIZE (L X W X H)		WEIGHT	
		MM	IN	LB	
105692	6' Plaza Bench (Cedar) Complete	1829 x 800 x 914	72 x 31.5 x 36	375	
105687	Plaza Bench Ends (Pebblestone)	102 x 800 x 914	4 x 31.5 x 36	172	
105691	Cedar Seat & Back- Set	1829 x 394 x -	72 x 15.5 x -	62	

Notes: On-site assembly required. All cedar planks now have the option for Charcoal wood. For Pebblestone components, a Charcoal colour option is available (premium upcharge of 25%).



Site Furnishings

Wellington Bench

ITEM NO.	DESCRIPTION	UNIT			PRICE
		SIZE (L X W X H)		WEIGHT	
		MM	IN	LB	
105743	6' Wellington Bench Complete	1880 x 610 x 432	74 x 24 x 17	1452	
114689	6' Wellington Bench Complete with Indent	1880 x 610 x 432	74 x 24 x 17	1452	
105750	Wellington Bench Ends (Pebblestone)	610 x 102 x 660	24 x 4 x 26	270	
105748	Wellington Bench Seat	1676 x 610 x 102	66 x 24 x 4	458	
105746	Wellington Bench Back	1778 x 540 x 102	70 x 21.25 x 4	273	
105715	Sandblast Logo/Name on Concrete Bench	-	-	-	



Notes: On-site assembly required. Leveling screws are included in bench ends. Maximum depth indent is 3/4". For Pebblestone components, a Charcoal colour option is available (premium upcharge of 25%).

Brandon Bench

ITEM NO.	DESCRIPTION	UNIT			PRICE
		SIZE (L X W X H)		WEIGHT	
		MM	IN	LB	
105737	Brandon Bench Straight Complete	1829 x 559 x 470	72 x 22 x 18.5	795	
114685	Brandon Bench Straight Complete with Indent	1829 x 559 x 470	72 x 22 x 18.5	795	
105731	Brandon Bench Curved Complete	1829 x 559 x 470	72 x 22 x 18.5	795	
114682	Brandon Bench Curved Complete with Indent	1829 x 559 x 470	72 x 22 x 18.5	795	
105733	Brandon Bench Ends (Pebblestone)	457 x 152 x 368	18 x 6 x 14.5	123	
105735	Brandon Bench Curved Seat	1829 x 559 x 102	72 x 22 x 4	525	
105740	Brandon Bench Straight Seat	1829 x 559 x 102	72 x 22 x 4	524	



Notes: On-site assembly required. For Pebblestone components, a Charcoal colour option is available (premium upcharge of 25%).

72" Rectangular Picnic Table

ITEM NO.	DESCRIPTION	UNIT			PRICE
		SIZE (L X W X H)		WEIGHT	
		MM	IN	LB	
112708	72" Rectangular Picnic Table and/or Wheelchair Access	1829 x 1727 x 787	72 x 68 x 31	1552	
112711	72" Rectangular Picnic Table Plank	1829 x 279 x 70	72 x 11 x 2.75	182	
112703	72" Rectangular Picnic Table Leg	-	-	158	
112716	72" Rectangular Picnic Table Hardware Package (Brackets and Bolts)	-	-	-	
114824	72" Rectangular Picnic Table and/or Wheelchair Access Charcoal Polished	1829 x 1727 x 787	72 x 68 x 31	1552	



Notes: On-site assembly required. For Pebblestone components, a Charcoal colour option is available (premium upcharge of 25%). Planks can be installed as either a regular table or as wheelchair accessible. Seat has 2 sets of anchors cast in to allow for this flexibility.

Site Furnishings

Cast Patio Table (NEW)

ITEM NO.	DESCRIPTION	UNIT			PRICE
		SIZE (L X W X H)		WEIGHT	
		MM	IN	LB	
138393	Cast Patio Table Complete – White	1757 x 1757 x 470	67 x 67 x 18.5	880	
138394	Cast Patio Table Complete – Grey	1757 x 1757 x 470	67 x 67 x 18.5	880	
138395	Cast Patio Table Complete – Natural	1757 x 1757 x 470	67 x 67 x 18.5	880	
138396	Cast Patio Table Complete – Charcoal	1757 x 1757 x 470	67 x 67 x 18.5	880	
138296	Cast Patio Table Top – White	1016 x 1016 x 73	40 x 40 x 2.875	240	
138297	Cast Patio Table Top – Grey	1016 x 1016 x 73	40 x 40 x 2.875	240	
138298	Cast Patio Table Top – Natural	1016 x 1016 x 73	40 x 40 x 2.875	240	
138299	Cast Patio Table Top – Charcoal	1016 x 1016 x 73	40 x 40 x 2.875	240	
138300	Cast Patio Table Seat – White	889 x 279 x 73	35 x 11 x 2.875	60	
138301	Cast Patio Table Seat – Grey	889 x 279 x 73	35 x 11 x 2.875	60	
138302	Cast Patio Table Seat – Natural	889 x 279 x 73	35 x 11 x 2.875	60	
138303	Cast Patio Table Seat – Charcoal	889 x 279 x 73	35 x 11 x 2.875	60	
138312	Cast Patio Table Legs & Hardware – White	-	-	200	
138313	Cast Patio Table Legs & Hardware – Grey	-	-	200	
138314	Cast Patio Table Legs & Hardware – Natural	-	-	200	
138315	Cast Patio Table Legs & Hardware – Charcoal	-	-	200	

Notes: On-site assembly required. Mix and match colour options of our Cast Patio Table components to create a unique table.

Square Waste Container

ITEM NO.	DESCRIPTION	CAPACITY	UNIT			PRICE
			SIZE (L X W X H)		WEIGHT	
			L	MM	IN	
	Square Complete with Band, Lid, Liner and Base	97	610 x 610 x 1016	24 x 24 x 40	780	
105533	Custom Band Lettering	-	-	-	-	
105576	Container Only	192	610 x 610 x 864	24 x 24 x 34	690	
105520	Lid (Polyethylene)	-	610 x 610 x 152	24 x 24 x 6	6	
105597	Liner (Polyethylene)	92	457 x 457 x 610	18 x 18 x 24	10	
105625	Snuffer Attachment	-	305 x 152 x 203	12 x 6 x 8	20	

Notes: Lid and band colours, Red or Grey. Charcoal colour option available (premium upcharge of 25%).

Round Waste Container

ITEM NO.	DESCRIPTION	CAPACITY	UNIT			PRICE
			SIZE (L X W X H)		WEIGHT	
			L	MM	IN	
105496	22" Round with Flat Poly Lid and Liner	64	559 x 559 x 787	22 x 22 x 31	380	
105497	22" Round with Dome Lid and Liner	64	559 x 559 x 1067	22 x 22 x 42	380	
105505	26" Large Round with Dome Lid and Liner	134	660 x 660 x 1118	26 x 26 x 44	510	
105571	22" Round Container Only	121	559 x 559 x 787	22 x 22 x 31	415	
105574	26" Round Container Only	165	660 x 660 x 762	26 x 26 x 30	480	
105583	22" Flat Lid (Brown Polyethylene Weighted)	-	483 x 483 x 41	19 x 19 x 1.625	15	
105588	22" Dome Lid (Grey PVC)	-	584 x 584 x 279	23 x 23 x 11	15	
105591	26" Dome Lid (Grey PVC)	-	686 x 686 x 330	27 x 27 x 13	20	
105593	22" Liner (Polyethylene)	64	406 x 406 x 635	16 x 16 x 25	5	
105254	26" Liner (Polyethylene)	134	508 x 508 x 762	20 x 20 x 30	9	
105626	22" Snuffer Attachment with Drain Holes	3.7	330 x 152 x 203	13 x 6 x 8	20	
105627	26" Snuffer Attachment with Drain Holes	3.7	330 x 152 x 203	13 x 6 x 8	20	

Notes: For Pebblestone components, a Charcoal colour option is available (premium upcharge of 25%).



Site Furnishings

Pebblestone Snuffers

ITEM NO.	DESCRIPTION	UNIT			PALLET		PRICE
		SIZE (L X W X H)		WEIGHT	NO. OF	WEIGHT	
		MM	IN	LB	UNITS	LB	
105620	10" Square Pebblestone	254 x 254 x 610	10 x 10 x 24	175	16	-	
105630	18" Square Pebblestone	457 x 457 x 610	18 x 18 x 24	388	8	-	
105618	22" Round Pebblestone	559 x 559 x 762	22 x 22 x 30	360	4	-	
100958	Silica Sand (20 kg/Bag)	-	-	44	-	-	

Notes: For Pebblestone components, a Charcoal colour option is available (premium upcharge of 25%). Packaging required, sold by the piece.



Umbrella Base

ITEM NO.	DESCRIPTION	UNIT			PALLET		PRICE
		SIZE (D X H)		WEIGHT	NO. OF	WEIGHT	
		MM	IN	LB	UNITS	LB	
112547	Umbrella Base Pebblestone	381 x 254	15 x 10	36	26	-	



Recycle Container

ITEM NO.	DESCRIPTION	UNIT			PRICE
		SIZE (L X W X H)		WEIGHT	
		MM	IN	LB	
105547	Square Complete with Lid, Two Logo Discs, Liner and Base	610 x 610 x 1016	24 x 24 x 40	700	



GFRC

Elan Planters

DESCRIPTION	UNIT			PRICE
	SIZE (L/W X H, BASE L/W)		WEIGHT	
	MM	IN	LB	
Elan Square	610 x 432, 381	24 x 17, 15	125	
Elan Square	914 x 559, 432	36 x 22, 17	235	
Elan Square	914 x 762, 495	36 x 30, 19.5	295	
Elan Square	1219 x 762, 660	48 x 30, 26	450	



DESCRIPTION	UNIT			PRICE
	SIZE (D X H, BASE D)		WEIGHT	
	MM	IN	LB	
Elan Round	610 x 432, 381	24 x 17, 15	100	
Elan Round	914 x 559, 495	36 x 22, 19.5	192	
Elan Round	914 x 711, 432	36 x 28, 17	265	
Elan Round	1219 x 762 x 660	48 x 30, 26	410	



Notes: See colour chart for available colours. Custom colours are available. Contact Barkman for more details. Upon ordering, please specify which finish you require (smooth or textured) and if the application is for outdoor or indoor use.

Montana Planters

DESCRIPTION	UNIT			PRICE
	SIZE (D X H, BASE D)		WEIGHT	
	MM	IN	LB	
Montana Round	610 x 432, 229	24 x 17, 9	100	
Montana Round	610 x 559, 254	24 x 22, 10	125	
Montana Round	762 x 559, 381	30 x 22, 15	165	
Montana Round	914 x 432, 432	36 x 17, 17	180	
Montana Round	914 x 559, 318	36 x 22, 12.5	195	
Montana Round	1219 x 432, 457	48 x 17, 18	220	
Montana Round	1219 x 559, 406	48 x 22, 16	325	
Montana Round	1219 x 762, 635	48 x 30, 25	455	
Montana Round	1524 x 432, 559	60 x 17, 22	350	
Montana Round	1524 x 559, 660	60 x 22, 26	475	
Montana Round	1829 x 432, 572	72 x 17, 22.5	500	
Montana Round	1829 x 559, 711	72 x 22, 28	675	



Notes: See colour chart for available colours. Custom colours are available. Contact Barkman for more details. Upon ordering, please specify which finish you require (smooth or textured) and if the application is for outdoor or indoor use.

GFRC

Santa Fe Planters

DESCRIPTION	UNIT			PRICE
	SIZE (D X H, BASE D)		WEIGHT	
	MM	IN	LB	
Santa Fe Round	610 x 305, 432	24 x 12, 17	75	
Santa Fe Round	610 x 432, 432	24 x 17, 17	100	
Santa Fe Round	610 x 559, 483	24 x 22, 19	125	
Santa Fe Round	914 x 432, 787	36 x 17, 31	180	
Santa Fe Round	914 x 559, 813	36 x 22, 32	192	
Santa Fe Round	914 x 762, 724	36 x 30, 28.5	265	
Santa Fe Round	1219 x 559, 1092	48 x 22, 43	325	
Santa Fe Round	1219 x 914, 965	48 x 36, 38	475	
Santa Fe Round	1524 x 559, 1295	60 x 22, 51	475	
Santa Fe Round	1524 x 914, 1270	60 x 36, 50	580	
Santa Fe Round	1676 x 1067, 1321	66 x 42, 52	1000	
Santa Fe Round	1829 x 559, 1575	72 x 22, 62	675	



DESCRIPTION	UNIT			PRICE
	SIZE (L X W X H, BASE L X W)		WEIGHT	
	MM	IN	LB	
Santa Fe Rectangular	914 x 610 x 610, 686 x 381	36 x 24 x 24, 27 x 15	275	
Santa Fe Rectangular	991 x 838 x 610, 787 x 787	39 x 33 x 24, 31 x 31	300	
Santa Fe Rectangular	1829 x 762 x 762, 1676 x 610	72 x 30 x 30, 66 x 24	700	

DESCRIPTION	UNIT			PRICE
	SIZE (L/W X H, BASE L/W)		WEIGHT	
	MM	IN	LB	
Santa Fe Square	610 x 559, 483	24 x 22, 19	170	
Santa Fe Square	991 x 559, 864	39 x 22, 34	225	
Santa Fe Square	991 x 762, 813	39 x 30, 32	300	
Santa Fe Square	1194 x 914, 1041	47 x 36, 41	550	
Santa Fe Square	1829 x 762, 1676	72 x 30, 66	1100	



Notes: See colour chart for available colours. Custom colours are available. Contact Barkman for more details. Upon ordering, please specify which finish you require (smooth or textured) and if the application is for outdoor or indoor use.

Newport Planters

DESCRIPTION	UNIT			PRICE
	SIZE (L X W X H, BASE L X W)		WEIGHT	
	MM	IN	LB	
Newport Rectangular	1829 x 610 x 584, 457 x 1575	72 x 24 x 23, 18 x 62	490	



GFRC

Newport Planters

DESCRIPTION	UNIT			PRICE
	SIZE (D X H, BASE D)		WEIGHT	
	MM	IN	LB	
Newport Round	610 x 432, 305	24 x 17, 12	100	
Newport Round	610 x 559, 305	24 x 22, 12	125	
Newport Round	610 x 762, 356	24 x 30, 14	150	
Newport Round	762 x 762, 419	30 x 30, 16.5	200	
Newport Round	914 x 559, 483	36 x 22, 19	195	
Newport Round	914 x 762, 495	36 x 30, 19.5	265	
Newport Round	1219 x 660, 673	48 x 26, 26.5	400	
Newport Round	1219 x 762, 610	48 x 30, 24	410	
Newport Round	1219 x 914, 610	48 x 36, 24	475	
Newport Round	1524 x 914, 876	60 x 36, 34.5	580	
Newport Round	1829 x 914, 1156	72 x 36, 45.5	925	



Notes: See colour chart for available colours. Custom colours available. Contact Barkman for more details. Upon ordering, please specify which finish you require (smooth or textured) and if the application is for outdoor or indoor use.

Contempra Planters

DESCRIPTION	UNIT			PRICE
	SIZE (L/W X H, BASE L/W)		WEIGHT	
	MM	IN	LB	
Contempra Square	432 x 610, 254	17 x 24, 10	80	
Contempra Square	457 x 762, 254	18 x 30, 10	130	
*Contempra Square	457 x 914, 254	18 x 36, 10	150	
*Contempra Square	508 x 1016, 305	20 x 40, 12	200	
Contempra Square	610 x 432, 305	24 x 17, 12	125	
Contempra Square	610 x 559, 305	24 x 22, 12	150	
Contempra Square	838 x 559, 381	33 x 22, 15	225	
Contempra Square	914 x 432, 432	36 x 17, 17	200	
Contempra Square	914 x 762, 381	36 x 30, 15	300	
Contempra Square	1092 x 559, 610	43 x 22, 24	350	
Contempra Square	1143 x 762, 610	45 x 30, 24	370	



DESCRIPTION	UNIT			PRICE
	SIZE (D X H, BASE D)		WEIGHT	
	MM	IN	LB	
Contempra Round	457 x 914, 254	18 x 36, 10	140	
Contempra Round	610 x 305, 305	24 x 12, 12	75	
Contempra Round	610 x 432, 305	24 x 17, 12	100	
Contempra Round	610 x 559, 279	24 x 22, 11	125	
Contempra Round	914 x 432, 394	36 x 17, 15.5	180	
Contempra Round	914 x 559, 406	36 x 22, 16	195	
Contempra Round	914 x 762, 394	36 x 30, 15.5	265	
Contempra Round	1219 x 432, 584	48 x 17, 23	220	
Contempra Round	1219 x 559, 584	48 x 22, 23	325	
Contempra Round	1219 x 762, 610	48 x 30, 24	410	
Contempra Round	1524 x 432, 572	60 x 17, 22.5	350	
Contempra Round	1829 x 432, 622	72 x 17, 24.5	500	
Contempra Round	2438 x 559, 902	96 x 22, 35.5	1000	



Notes: See colour chart for available colours. Custom colours are available. Contact Barkman for more details. *Comes with false bottoms approximately 18" down. Upon ordering, please specify which finish you require (smooth or textured) and if the application is for outdoor or indoor use.

GFRC

Cube Planters

DESCRIPTION	UNIT			WEIGHT	PRICE
	SIZE (L X W X H, BASE L X W)				
	MM	IN	LB		
Cube Square	508 x 508 x 762, 508 x 508	20 x 20 x 30, 20 x 20	130		
Cube Square	508 x 508 x 914, 508 x 508	20 x 20 x 36, 20 x 20	150		
Cube Square	508 x 508 x 1016, 508 x 508	20 x 20 x 40, 20 x 20	200		
Cube Square	610 x 610 x 610, 610 x 610	24 x 24 x 24, 24 x 24	150		
Cube Square	610 x 610 x 762, 610 x 610	24 x 24 x 30, 24 x 24	195		
Cube Square	610 x 610 x 914, 610 x 610	24 x 24 x 36, 24 x 24	240		
Cube Square	762 x 762 x 610, 762 x 762	30 x 30 x 24, 30 x 30	170		
Cube Square	762 x 762 x 762, 762 x 762	30 x 30 x 30, 30 x 30	215		
Cube Square	762 x 762 x 914, 762 x 762	30 x 30 x 36, 30 x 30	265		
Cube Square	914 x 914 x 610, 914 x 914	36 x 36 x 24, 36 x 36	295		
Cube Square	914 x 914 x 762, 914 x 914	36 x 36 x 30, 36 x 36	340		
Cube Square	914 x 914 x 914, 914 x 914	36 x 36 x 36, 36 x 36	390		
Cube Square	1143 x 1143 x 610, 1143 x 1143	45 x 45 x 24, 45 x 45	390		
Cube Square	1143 x 1143 x 762, 1143 x 1143	45 x 45 x 30, 45 x 45	440		
Cube Square	1143 x 1143 x 914, 1143 x 1143	45 x 45 x 36, 45 x 45	500		
Cube Rectangular	914 x 406 x 610, 914 x 406	36 x 16 x 24, 36 x 16	170		
Cube Rectangular	914 x 406 x 762, 914 x 406	36 x 16 x 30, 36 x 16	190		
Cube Rectangular	914 x 406 x 914, 914 x 406	36 x 16 x 36, 36 x 16	220		
Cube Rectangular	1219 x 406 x 610, 1219 x 406	48 x 16 x 24, 48 x 16	230		
Cube Rectangular	1219 x 406 x 762, 1219 x 406	48 x 16 x 30, 48 x 16	255		
Cube Rectangular	1219 x 406 x 914, 1219 x 406	48 x 16 x 36, 48 x 16	290		
Cube Rectangular	1219 x 610 x 610, 1219 x 610	48 x 24 x 24, 48 x 24	400		
Cube Rectangular	1219 x 610 x 762, 1219 x 610	48 x 24 x 30, 48 x 24	440		
Cube Rectangular	1219 x 610 x 914, 1219 x 610	48 x 24 x 36, 48 x 24	480		
Cube Rectangular	1524 x 610 x 610, 1524 x 610	60 x 24 x 24, 60 x 24	450		
Cube Rectangular	1524 x 610 x 762, 1524 x 610	60 x 24 x 30, 60 x 24	480		
Cube Rectangular	1524 x 610 x 914, 1524 x 610	60 x 24 x 36, 60 x 24	520		
Cube Rectangular	1829 x 610 x 610, 1829 x 610	72 x 24 x 24, 72 x 24	500		
Cube Rectangular	1829 x 610 x 762, 1829 x 610	72 x 24 x 30, 72 x 24	550		
Cube Rectangular	1829 x 610 x 914, 1829 x 610	72 x 24 x 36, 72 x 24	600		



Notes: Upon ordering, please specify which finish you require (smooth or textured) and if the application is for outdoor or indoor use.

Self Watering Units

ITEM NO.	DESCRIPTION	UNIT			WEIGHT	VOLUME	PRICE
		SIZE (L X W X H)					
		MM	IN	LB			
115463	10" Round	254 x 254 x 178	10 x 10 x 7	5	2.2		
115464	18" Round	457 x 457 x 203	18 x 18 x 8	9	8.4		
115465	18" Square	457 x 457 x 203	18 x 18 x 8	11	10.57		
115466	24" Square	610 x 610 x 203	24 x 24 x 8	15	18.9		



Notes: Multiple units can be joined together for larger planters. See installation instructions or contact a Barkman representative for more details.

GFRC

Trays

DESCRIPTION	UNIT			PRICE
	SIZE (OUTSIDE D/INSIDE D X H)		WEIGHT	
	MM	IN	LB	
Trays Round	470/381 x 44	18.5/15 x 1.75	36	
Trays Round	610/502 x 51	24/19.75 x 2	50	
Trays Round	914/762 x 64	36/30 x 2.5	75	
Trays Round	1022/864 x 76	40.25/34 x 3	100	
Trays Round	1359/1137 x 76	53.5/44.75 x 3	250	
Trays Round	1613/1372 x 95	63.5/54 x 3.75	350	
Trays Round	1956/1740 x 89	77/68.5 x 3.5	375	
Trays Square	508/406 x 76	20/16 x 3	32	
Trays Square	610/457 x 76	24/18 x 3	42	
Trays Square	699/546 x 76	27.5/21.5 x 3	52	
Trays Square	991/838 x 89	39/33 x 3.5	75	
Trays Square	1295/1118 x 89	51/44 x 3.5	240	



Waste Containers

ITEM NO.	DESCRIPTION	CAPACITY L	UNIT		WEIGHT LB	PRICE
			SIZE (D X H)			
			MM	IN		
	Santa Fe Complete with Lid and Poly Liner	136	737 x 813	29 x 32	205	
	Santa Fe Complete with Ashtray, Trash Lid and \Poly Liner	136	737 x 813	29 x 32	205	
132133	Santa Fe Container Only	-	737 x 813	29 x 32	195	
132131	Contempra with Lid and Poly Liner	136	686 x 813	27 x 32	205	
132149	Contempra with Ashtray, Trash Lid and Poly Liner	136	686 x 813	27 x 32	205	
132167	Contempra Container Only	-	686 x 813	27 x 32	195	
132185	Newport Complete with Lid and Poly Liner	136	686 x 813	27 x 32	205	
132203	Newport Complete with Ashtray, Trash Lid and Poly Liner	136	686 x 813	27 x 32	205	
132221	Newport Container Only	-	686 x 813	27 x 32	195	
105253	Lid Only Component	-	616 x 1219	24.25 x 48	3	
105252	Ash and Trash Lid Only Component	-	616 x 89	24.25 x 3.5	3	
105254	Poly Liner Only Component	136	508 x 635	20 x 25	7	



Notes: Trash lid and ash/trash lid are spun aluminum

Cube Garden Bench

ITEM NO.	DESCRIPTION	UNIT			PRICE
		SIZE (L X W X H)		WEIGHT	
		MM	IN	LB	
	Garden Bench	1600 x 508 x 508	63 x 20 x 20	450	

Note: Trex decking utilized for seat. Available Trex colours are Gravel Path, Island Mist, Winchester Grey, Saddle and Woodland Brown



Island Mist

Gravel Path

Winchester Grey

Saddle

Woodland Brown

GFRC

GFRC Benches

ITEM NO.	DESCRIPTION	UNIT			PRICE
		SIZE (L X W X H)		WEIGHT	
		MM	IN	LB	
	Oxford Bench Complete	1676 x 457 x 457	66 x 18 x 18	530	
	Oxford End	432 x 457 x 152	17 x 18 x 6	176	
	Oxford Seat	1524 x 457 x 64	60 x 18 x 2.5	178	
	Santa Fe Bench Complete	1676 x 457 x 457	66 x 18 x 18	530	
	Santa Fe End	432 x 457 x 152	17 x 18 x 6	176	
	Santa Fe Seat	1524 x 457 x 64	60 x 18 x 2.5	178	
	Newport Bench Complete	1676 x 457 x 457	66 x 18 x 18	530	
	Newport End	432 x 457 x 203	17 x 18 x 8	176	
	Newport Seat	1524 x 457 x 64	60 x 18 x 2.5	178	

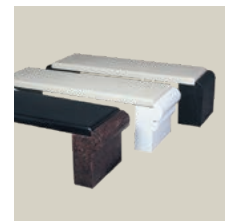

Ash Urns

ITEM NO.	DESCRIPTION	UNIT			PRICE
		SIZE (L X W X H)		WEIGHT	
		MM	IN	LB	
	Tuscany Square – Ash Urn with GFRC Tray	356 x 356 x 521	14 x 14 x 20.5	90	
	GFRC Tuscany Tray Only	248 x 248 x 90	9.75 x 9.75 x 2.75	4	
	Tuscany Square Container Only	356 x 356 x 521	14 x 14 x 20.5	85	
	Santa Fe – Ash Urn with Aluminum Tray	381 x 381 x 533	15 x 15 x 21	90	
	Santa Fe Round Container Only	381 x 381 x 533	15 x 15 x 21	90	
	Newport – Ash Urn with Aluminum Tray	381 x 381 x 533	15 x 15 x 21	90	
	Newport Round Container Only	381 x 381 x 533	15 x 15 x 21	90	
	Oxford – Ash Urn with Aluminum Tray	381 x 381 x 533	15 x 15 x 21	90	
	Oxford Round Container Only	381 x 381 x 533	15 x 15 x 21	90	
	Aluminum Tray Only	298 x 298 x 76	11.75 x 11.75 x 3	.75	



Specialty Products

Bicycle Stands

ITEM NO.	DESCRIPTION	UNIT			PALLET		PRICE
		SIZE (L X W X H)		WEIGHT	NO. OF	WEIGHT	
		MM	IN	LB	UNITS	LB	
105491	Pebblestone	787 x 305 x 152	31 x 12 x 6	100	16	1600	
105490	Natural	787 x 305 x 152	31 x 12 x 6	100	16	1600	
105492	Locking Rings with Zinc Dichromate Plating	-	-	-	-	-	

Notes: Locking ring attaches to Bicycle Stand. Must be purchased separately.



Splash Pads

ITEM NO.	DESCRIPTION	UNIT			PALLET		PRICE
		SIZE (L X W X H)		WEIGHT	NO. OF	WEIGHT	
		MM	IN	LB	UNITS	LB	
105603	24" Natural	610 x 305 x 64	24 x 12 x 2.5	47	15	705	
105604	30" Natural	762 x 305 x 64	30 x 12 x 2.5	61	15	915	
105608	51" Natural	1295 x 368 x 127	51 x 14.5 x 5	212	12	2544	
105612	96" Natural	2438 x 610 x 152	96 x 24 x 6	345	1	730	
105610	Mounting Bracket	76 x 76 x 305	3 x 3 x 12	2	-	-	

Notes: For 51" Splash Pad, bracket sold separately. 24" and 30" Splash Pads sold in full bundles only.



Rain Drain

ITEM NO.	DESCRIPTION	UNIT			PALLET		PRICE
		SIZE (L X W X H)		WEIGHT	NO. OF	WEIGHT	
		MM	IN	LB	UNITS	LB	
105613	Rain Drain/Floor Drain	394 x 279 x 267	15.5 x 11 x 10.5	60	27	1620	
105614	Replacement Covers	330 x 216 x -	13 x 8.5 x -	2	-	-	

Notes: Size of outlet 2", 3" or 4". Desired size of knockout can be selected. Sold by the piece.

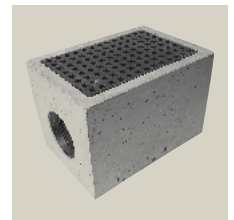

Barrier Curbs

ITEM NO.	DESCRIPTION	UNIT			PALLET		PRICE
		SIZE (L X W AT BASE X H)		WEIGHT	NO. OF	WEIGHT	
		MM	IN	LB	UNITS	LB	
106470	120" x 26"	3048 x 425 x 660	120 x 16.75 x 26	1570	-	-	
106484*	120" x 30"	3048 x 425 x 762	120 x 16.75 x 30	2225	-	-	
106489	60" x 26"	1524 x 425 x 660	60 x 16.75 x 26	775	-	-	
106488*	60" x 30"	1524 x 425 x 762	60 x 16.75 x 30	1115	-	-	

Notes: *30" high Barrier Curbs have forklift pockets. No pallet required. 105934 - barrier curb lifting ring with 3/4" thread, lifts up to 7200 lbs.



Highway Barrier Curbs

ITEM NO.	DESCRIPTION	UNIT			PALLET		PRICE
		SIZE (L X W X H)		WEIGHT	NO. OF	WEIGHT	
		MM	IN	LB	UNITS	LB	
106480	60"	1524 x 572 x 851	60 x 22.5 x 33.5	2150	-	-	
106476	120"	3048 x 572 x 851	120 x 22.5 x 33.5	4300	-	-	

Notes: Lifting eyes sold separately. Highway barrier curbs have forklift pockets.

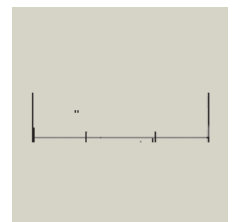

Specialty Products

Curbs

ITEM NO.	DESCRIPTION	UNIT			PALLET		PRICE
		SIZE (L X W X H)		WEIGHT	NO. OF	WEIGHT	
		MM	IN	LB	UNITS	LB	
105179	Parking	2438 x 203 x 140	96 x 8 x 5.5	340	10	3400	
105181	Landscape (Natural colour)	2743 x 203 x 152	108 x 8 x 6	435	8	3480	
105185	Truck Curb (Natural colour)	3048 x 254 x 254	120 x 10 x 10	1020	1	1020	

Notes: Parking Curb includes 2 pins (15mm x 432mm). Sold by the piece.



Boat Ramp Pads

ITEM NO.	DESCRIPTION	UNIT			PRICE
		SIZE (L X W X H)		WEIGHT	
		MM	IN	LB	
105669	10'/120"	3048 x 356 x 102	120 x 14 x 4	565	
105673	12'/144"	3658 x 432 x 127	144 x 17 x 5	1011	

Notes: 12' Boat Ramp Pad coverage is 17" per Boat Ramp Pad. 5/8" x 3/4" bolts are included. Detailed specifications available. 1/2" cable not supplied. 20 mm pipe sleeve not supplied. 10' Boat Ramp Pad includes bolting tabs.

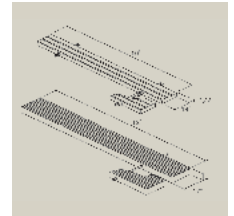

Pool Heater Pad

ITEM NO.	DESCRIPTION	UNIT			PALLET		PRICE
		SIZE (L X W X H)		WEIGHT	NO. OF	WEIGHT	
		MM	IN	LB	UNITS	LB	
106018	Pool Heater Pad	1016 x 1016 x 76	40 x 40 x 3	330	5	1980	

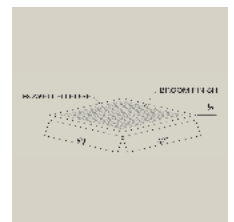

Slab Steps

Rosetta® Irregular Steps

DESCRIPTION	UNIT			PALLET		PRICE
	SIZE (L X W X H)		WEIGHT	NO. OF	WEIGHT	
	MM	IN	LB	UNITS	LB	
A	1372 x 559 x 178	54 x 22 x 7	458	1	2962	
B	1524 x 610 x 178	60 x 24 x 7	600	1		
C	1067 x 432 x 178	42 x 17 x 7	349	1		
D	1219 x 711 x 178	48 x 28 x 7	567	1		
E	1067 x 660 x 178	42 x 26 x 7	476	1		
F	1219 x 610 x 178	48 x 24 x 7	512	1		

COLOURS	ITEM NO.
Fon du Lac	104016
Copper Canyon	104017
Pacific Grey	104018

Notes: A, B, C, D, E and F sold together in full pallets only. A \$25.00 returnable pallet fee will be charged to any pallet of Irregular Steps.



Rosetta® Dimensional Steps

DESCRIPTION	UNIT			PALLET		PRICE
	SIZE (L X W X H)		WEIGHT	NO. OF	WEIGHT	
	MM	IN	LB	UNITS	LB	
3'	914 x 457 x 178	36 x 18 x 7	375	6	2250	
4'	1219 x 457 x 178	48 x 18 x 7	455	6	2730	
6'	1829 x 762 x 178	72 x 30 x 7	1320	2	2640	

COLOURS	ITEM NO. 3'	ITEM NO. 4'	ITEM NO. 6'
Fon du Lac	104032	104031	104033
Copper Canyon	104029	104028	104030
Pacific Grey	104035	104034	104036

Notes: A \$25.00 returnable pallet fee will be charged to any pallet of Dimensional Steps.



Bridgewood Steps

DESCRIPTION	UNIT			PALLET		PRICE
	SIZE (L X W X H)		WEIGHT	NO. OF	WEIGHT	
	MM	IN	LB	UNITS	LB	
Bridgewood 48" Steps	1200 x 400 x 140	47.24 x 17.75 x 5.51	380	8	3040	

COLOURS	ITEM NO.
Cedar Brown	116941
Weathered Grey	116940

Notes: Colours for Bridgewood Steps are not exact replications of Bridgewood Slab's Weathered Grey and Cedar Brown.



Steps

Sectional Steps

DESCRIPTION	NO. OF RISERS	PLATFORM SIZE				
		610 MM/24 IN	1067 MM/42 IN	1219 MM/48 IN	1524 MM/60 IN	1829 MM/72 IN
		WEIGHT				
		LB	LB	LB	LB	LB
3' Wide	1	-	-	474	582	-
3' Wide	2	-	-	644	752	-
3' Wide	3	-	-	814	922	-
3' Wide	4	-	-	984	1092	-
3' Wide	5	-	-	1154	1262	-
4' Wide	1	-	-	632	777	-
4' Wide	2	-	-	858	1003	-
4' Wide	3	-	-	1085	1230	-
4' Wide	4	-	-	1312	1457	-
4' Wide	5	-	-	1539	1684	-
5' Wide	1	-	-	790	972	-
5' Wide	2	-	-	1073	1254	-
5' Wide	3	-	-	1356	1537	-
5' Wide	4	-	-	1639	1820	-
5' Wide	5	-	-	1922	2103	-
6' Wide	1	-	-	948	1166	-
6' Wide	2	-	-	1286	1505	-
6' Wide	3	-	-	1627	1844	-
6' Wide	4	-	-	1966	2183	-
6' Wide	5	-	-	2305	2522	-
7' Wide	1	-	-	1106	1360	-
7' Wide	2	-	-	1502	1756	-
7' Wide	3	-	-	1898	2152	-
7' Wide	4	-	-	2294	2548	-
7' Wide	5	-	-	2690	2944	-
8' Wide	1	-	-	1264	1554	-
8' Wide	2	-	-	1717	2005	-
8' Wide	3	-	-	2169	2459	-
8' Wide	4	-	-	2622	2913	-
8' Wide	5	-	-	3075	3366	-
9' Wide	1	-	-	1422	1749	-
9' Wide	2	-	-	1931	2258	-
9' Wide	3	-	-	2440	2767	-
9' Wide	4	-	-	2949	3276	-
9' Wide	5	-	-	3458	3785	-
10' Wide	1	-	-	1581	1943	-
10' Wide	2	-	-	2146	2508	-
10' Wide	3	-	-	2712	3073	-
10' Wide	4	-	-	3277	3638	-
10' Wide	5	-	-	3842	4203	-
11' Wide	1	-	-	1739	2137	-
11' Wide	2	-	-	2361	2759	-
11' Wide	3	-	-	2984	3381	-
11' Wide	4	-	-	3605	4003	-
11' Wide	5	-	-	4226	4624	-
12' Wide	1	-	-	1898	2332	-
12' Wide	2	-	-	2576	3010	-
12' Wide	3	-	-	3256	3688	-
12' Wide	4	-	-	3933	4366	-
12' Wide	5	-	-	4610	5043	-

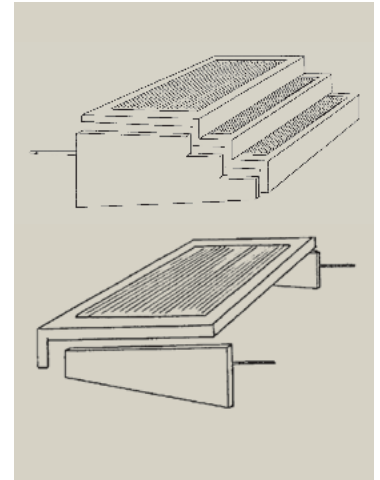

Notes: 60" and 72" platform available upon request. Contact Barkman for quote. Fractional widths are available; these will be charged to the next foot. It is manufactured in three pieces. The steps and platform are in one section and the sides are separate. Surface of the steps, platform and the sides of brackets are a "broom finish". Each riser is 7.25" high, first riser is 10.25", tread depth is 11". Holes will need to be drilled to attach rails (fasteners not included). These steps are ordered on a custom basis for Winnipeg only. Angled platforms available. Subject to truck accessibility.

Steps

Sectional Brackets

ITEM NO.	DESCRIPTION	UNIT			PRICE
		SIZE (L X W X H)		WEIGHT	
		MM	IN	LB	
101585	1 Riser – 44" Concrete Bracket	-	-	131	
101586	2 Riser – 44" Concrete Bracket	-	-	181	
101587	3 Riser – 44" Concrete Bracket	-	-	202	
101588	4 Riser – 44" Concrete Bracket	-	-	231	

Notes: Please specify bolt-on or pier mount. Available in Winnipeg only. Custom sizing available, call for pricing.

Dura-Lite Steps 2.5" Plank Thickness

DESCRIPTION	NO. OF RISERS	PLATFORM SIZE					PRICE
		305MM/12 IN	1067 MM/42 IN	1219 MM /48 IN	1524 MM/60 IN SE	1524 MM/60 IN UP & OVER/SE	
		WEIGHT					
		LB	LB	LB	LB	LB	
4' Wide	2	320	-	660	770	880	
4' Wide	3	430	-	770	880	1090	
4' Wide	4	540	-	880	990	1310	
4' Wide	5	650	-	990	1090	1530	
4' Wide	6	760	-	1090	1200	1750	
5' Wide	2	374	-	785	922	1059	
5' Wide	3	511	-	922	1059	1333	
5' Wide	4	648	-	1059	1196	1607	
5' Wide	5	785	-	1196	1333	1881	
5' Wide	6	922	-	1333	1470	2155	

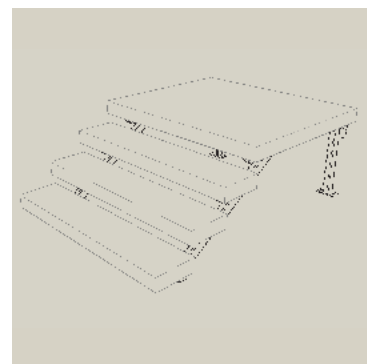

Notes: Each riser is 7.25" high, plank depth is 12". Complete kits include step frames, concrete planks, and hardware. Side entrance prices include one leg and two side mounting brackets. All Pebblestone planks available in Charcoal. Add 15% upcharge for Charcoal. Dura-Lite frames can also be sold separately. Custom riser heights available, call for additional information. Available in Winnipeg only.

Dura-Lite Steps 4" Plank Thickness

DESCRIPTION	NO. OF RISERS	PLATFORM SIZE					PRICE
		305MM/12 IN	1067 MM/42 IN	1219 MM /48 IN	1524 MM/60 IN SE	1524 MM/60 IN UP & OVER/SE	
		WEIGHT					
		LB	LB	LB	LB	LB	
4' Wide	2	512	-	1140	1336	1542	
4' Wide	3	618	-	1346	1542	1954	
4' Wide	4	824	-	1552	1748	2366	
4' Wide	5	1030	-	1758	1954	2778	
4' Wide	6	2260	-	1964	2160	3190	
5' Wide	2	616	-	1390	1648	1906	
5' Wide	3	737	-	1548	1906	2422	
5' Wide	4	858	-	1806	2422	2938	
5' Wide	5	797	-	2422	2580	3454	
5' Wide	6	1100	-	2680	2838	3970	
6' Wide	2	770	-	1650	1960	2270	
6' Wide	3	1030	-	1960	2270	2890	
6' Wide	4	1340	-	2270	2580	3510	
6' Wide	5	1650	-	2580	2890	4130	
6' Wide	6	1960	-	2890	3200	4750	

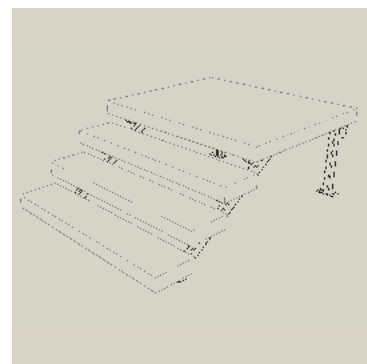

Notes: Each riser is 7.25" high, plank depth is 12". Complete kits include step frames, concrete planks, and hardware. Side entrance prices include one leg and two side mounting brackets. All Pebblestone planks available in Charcoal. Add 15% upcharge for Charcoal. Dura-Lite frames can also be sold separately. Custom riser heights available, call for additional information. Available in Winnipeg only.

Steps

Dura-Lite Concrete Pebblestone Planks

ITEM NO.	DESCRIPTION	UNIT			PRICE
		SIZE (L X W X H)		WEIGHT	
		MM	IN	LB	
102000	36" Concrete Step Plank (Pebblestone)	914 x 305 x 64	36 x 12 x 2.5	95	
102002	48" Concrete Step Plank (Pebblestone)	1219 x 305 x 64	48 x 12 x 2.5	110	
101997	60" Concrete Step Plank (Pebblestone)	1524 x 305 x 64	60 x 12 x 2.5	137	
102089	48" Concrete Step Plank (Pebblestone)	1219 x 305 x 102	48 x 12 x 4	206	
102017	60" Concrete Step Plank (Pebblestone)	1524 x 305 x 102	60 x 12 x 4	258	
119217	72" Concrete Step Plank (Pebblestone)	1829 x 305 x 102	72 x 12 x 4	310	

Notes: Available in regular Pebblestone or Charcoal Pebblestone. Charcoal is a 15% upcharge. One piece platform available, call for pricing. Available in Winnipeg only.

Legacy Steps (NEW)

DESCRIPTION	PLATFORM SIZE		PRICE
	48 IN	60 IN (SE)	
	WEIGHT		
	LB	LB	
4' Wide 1r	943	1271	
4' Wide 2r	1343	1783	
4' Wide 3r	1894	2465	
4' Wide 4r	2525	3226	
4' Wide 5r	3236	4066	
4' Wide 6r	4026	4987	
5' Wide 1r	1046	1422	
5' Wide 2r	1572	2100	
5' Wide 3r	2178	2858	
5' Wide 4r	2863	3696	
5' Wide 5r	3629	4613	
5' Wide 6r	4473	5609	
6' Wide 1r	1220	1663	
6' Wide 2r	1801	2418	
6' Wide 3r	2462	3252	
6' Wide 4r	3202	4166	
6' Wide 5r	4022	5159	
6' Wide 6r	4921	6232	

Notes: The 4' - 60" SE includes 2 - 50" brackets, 5' - 60" SE includes 2 - 72" brackets, 6' - 60" SE includes 2 - 84" brackets in price. Bolt type installation – each riser is 7.25" high, first riser is 10.25", tread depth is 11". Bracket type installation requires 2-50" brackets at extra cost. Holes need to be drilled to attach rails (fasteners not included). Engineered stamped drawings are available. Call Barkman for installation methods available and pricing. Available in Winnipeg only.

Cantilever Brackets

DESCRIPTION	UNIT			PRICE
	SIZE		WEIGHT	
	MM	IN	LB	
50" Concrete Bracket	1270	50	214	
60" Concrete Bracket	1524	60	249	
72" Concrete Bracket	1829	72	335	
84" Concrete Bracket	2134	84	553	
Concrete Bracket Saddle	-	-	70	

Notes: Available in Winnipeg only.

Septic Tanks

Standard Septic Tanks

ITEM NO.	DESCRIPTION	UNIT			TOTAL CAPACITY		PRICE
		SIZE (L X W X H)		WEIGHT	L	GAL	
		MM	IN	LB			
110895	750 Gallon Pump Tank	2438 x 1270 x 1625	96 x 50 x 64	7600	3400	898	
110901	750 Gallon Trickle Tank	2438 x 1270 x 1625	96 x 50 x 64	7600	3400	898	
110912	1000 Gallon Pump Tank	2438 x 1778 x 1752	96 x 70 x 69	11770	4545	1200	
110929	1000 Gallon Trickle Tank	2438 x 1778 x 1752	96 x 70 x 69	11770	4545	1200	
110917	1000 Gallon Holding Tank w/o Divider (H1)	2438 x 1778 x 1752	96 x 70 x 69	11310	4545	1200	
110935	1400 Gallon Pump Tank	2438 x 1879 x 2082	96 x 74 x 82	12365	6132	1620	
110937	1400 Gallon Trickle Tank	2438 x 1879 x 2082	96 x 74 x 82	12365	6132	1620	
110938	1400 Gallon Holding Tank w/o Divider (H1)	2438 x 1879 x 2082	96 x 74 x 82	11440	6132	1620	
110946	1500 Gallon Cistern with 4" vent	2438 x 1879 x 2082	96 x 74 x 82	11440	6810	1799	
111030	Modified with Holes	-	-	-	-	-	

Notes: Trickle tanks and septic tanks are custom orders.

Septic Tank Manhole Extensions

ITEM NO.	DESCRIPTION	UNIT				PRICE
		SIZE (INSIDE DIAMETER X OUTSIDE DIAMETER X H)		LENGTH	WEIGHT	
		MM	IN	FT	LB	
110973	Dry Cast Manhole Extension	762 x 889 x 152	30 x 35 x 6	258	130	
110971	Dry Cast Manhole Extension	762 x 889 x 304	30 x 35 x 12	-	258	
110974	Dry Cast Manhole Extension	762 x 889 x 457	30 x 35 x 18	-	387	
110976	Dry Cast Manhole Extension	762 x 889 x 609	30 x 35 x 24	-	534	
110952	Tank Lid With Handle (10 Per Pallet)	- x 889 x 76	- x 35 x 3	-	242	
127652	Tank Lid With 6-1/4" Hole	- x 889 x 76	- x 35 x 3	-	176	

Perma Septic Tanks

ITEM NO.	DESCRIPTION	UNIT			TOTAL CAPACITY		PRICE
		SIZE (L X W X H)		WEIGHT	L	GAL	
		MM	IN	LB			
110899	750 Gallon Pump Tank	2438 x 1270 x 1625	96 x 50 x 64	8500	3400	898	
110903	750 Gallon Trickle Tank	2438 x 1270 x 1625	96 x 50 x 64	8500	3400	898	
110911	1000 Gallon Pump Tank	2438 x 1778 x 1752	96 x 70 x 69	10740	4545	1200	
110928	1000 Gallon Trickle Tank	2438 x 1778 x 1752	96 x 70 x 69	10740	4545	1200	

Notes: 1 1/4" plug on pump tanks are custom orders. Trickle tanks are custom orders only.

Septic Tank Accessories

ITEM NO.	DESCRIPTION	UNIT			PRICE
		SIZE (OUTSIDE DIAMETER X H)		WEIGHT	
		MM	IN	LB	
111041	Septic tank Repair Form (Plastic)	-	-	50	
137851	Butyl Tape 1/2" x 3/4" 10' per roll/70' per case (7 rolls/case)	-	-	-	
110955	8" Steel Lid for H-1 Tanks	-	-	10	
111013	2 Piece Distribution Box	457 x 203	18 x 8	60	

Sump Pits

Well Cribbing & Sump Pump Pit

ITEM NO.	DESCRIPTION	UNIT					PRICE
		SIZE (INSIDE DIAMETER X OUTSIDE DIAMETER X H)		WEIGHT			
				TOTAL	WITHOUT BOTTOM	WITH BOTTOM	
		MM	IN	LB	LB	LB	
110983	36 x 6	914 x 1067 x 153	36 x 42 x 6		184		
110985	36 x 12	914 x 1067 x 305	36 x 42 x 12		349		
110986	36 x 18	914 x 1067 x 457	36 x 42 x 18		525		
117553	36 x 18 W/B	914 x 1067 x 457	36 x 42 x 18			810	
110987	36 x 24	914 x 1067 x 610	36 x 42 x 24		700		
111000	36 x 24 W/B	914 x 1067 x 610	36 x 42 x 24			985	
110988	36 x 30	914 x 1067 x 762	36 x 42 x 30		1110		
110990	36 x 36	914 x 1067 x 914	36 x 42 x 36		1200		
111001	36 x 36 W/B	914 x 1067 x 914	36 x 42 x 36			1395	
110997	48 x 12	1219 x 1372 x 305	48 x 54 x 12		421		
110998	48 x 18	1219 x 1372 x 457	48 x 54 x 18		629		
110999	48 x 24	1219 x 1372 x 610	48 x 54 x 24		560		
110991	48 x 36	1219 x 1372 x 914	48 x 54 x 36		1565		
111002	48 x 36 W/B	1219 x 1372 x 914	48 x 54 x 36			1983	
110994	60 x 12	1524 x 1676 x 305	60 x 66 x 12		502		
112607	60 x 12 W/B	1524 x 1676 x 305	60 x 66 x 12			942	
115085	60 x 24	1524 x 1676 x 610	60 x 66 x 24		1625		
115086	60 x 24 W/B	1524 x 1676 x 610	60 x 66 x 24			2583	
110993	60 x 36	1524 x 1676 x 914	60 x 66 x 36		2428		
111003	60 x 36 W/B	1524 x 1676 x 914	60 x 66 x 36			3377	
110996	60 x 60	1524 x 1676 x 1524	60 x 66 x 60		4047		
111004	60 x 60 W/B	1524 x 1676 x 1524	60 x 66 x 60			4996	
111008	Lid that Fits 36" Diameter	76 x 1067 x 914	3 x 42 x 36	350	-	-	
111010	Lid that Fits 48" Diameter (3 piece – 2 halves & 35" tank lid)	- x 1372 x 76	- x 54 x 3	576	-	-	
111011	Lid that Fits 60" Diameter (3 piece – 2 halves & 35" tank lid)	-	- x 66 x 4	1392	-	-	
111030	Modify with Holes	-	-	-	-	-	
137851	Butyl Sealant 1/2" x 3/4" Roll* x 10'L	-	-	-	-	-	

Notes: *Butyl Sealant come in 10' rolls, there are 7 rolls/case for a total of 70' per case. 3pc (2 halves & 35" tank lid). A \$25.00 returnable pallet fee will be charged on these units. Well cribbing and Sump Pump pits are custom orders.

Pallet Return Guide

Returnable Pallet

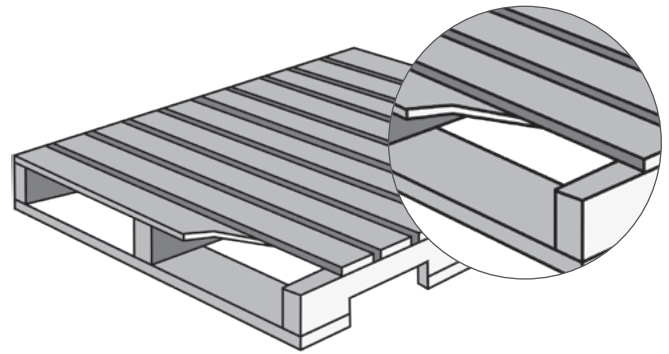
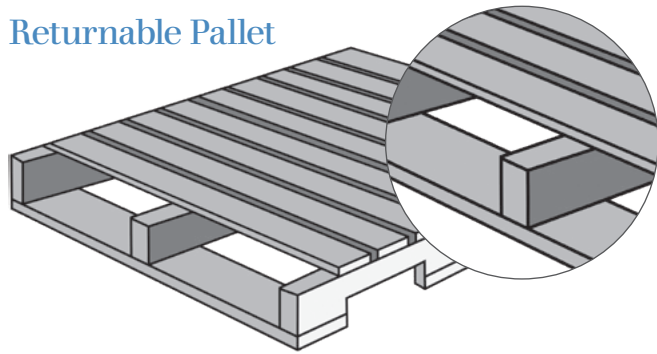

- ✓ Missing board, but stringers are still intact. ✓ Broken board, but stringers are intact.

Unreturnable Pallet

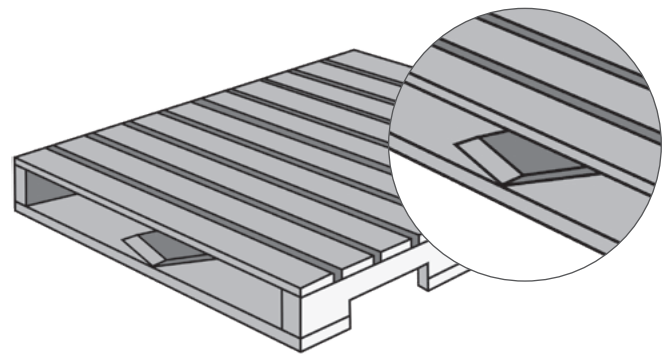
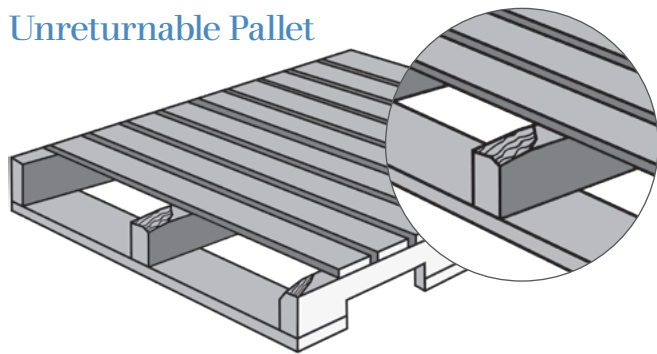

- ✗ Stringers have broken ends. ✗ Stringer is broken.

Notes: Only pallets with “Barkman” painted on the side will be received by Barkman. Other brand pallets or pallets without the “Barkman” paint will not be received and no credit will be issued. Barkman will only charge for pallets with the “Barkman” name on the side. Barkman will receive and credit in full returnable Barkman pallets that are in acceptable condition. Barkman works diligently to ensure no broken pallets leave our yard to your location. Should an “unacceptable” pallet be brought to your yard by delivery, please document it before being unloaded and inform Barkman immediately. This will ensure Barkman does not improperly invoice you for faulty product. Contact your nearest drop off yard before drop off to ensure the best possible service.

Important Information

The Environment

At Barkman we are committed to being good stewards of the planet. Not only are our products excellent choices for people concerned about the environment, we employ “environmental best practices” throughout our manufacturing and operations whenever possible.

Lifetime Warranty

All Barkman residential products are warranted against manufacturing defects for as long as you own your home. Should your Barkman product experience damage due to a manufacturing defect, Barkman will cheerfully replace the damaged product free of charge (proof of purchase is required). Colour matching cannot be guaranteed and installation labor is not included. This warranty does not include splitting, chipping, cracking or other damage that may be caused by impact, abrasion, overloading or improper installation. Refer to icpi.org for proper installation.

Efflorescence is not a manufacturer's defect and as such, is not covered under Barkman's product warranty.

Stainless Steel products in the Harvest Grove Collection are supplied by Sunstone™ Stainless Steel Grills. Warranty issues on all products supplied by Sunstone™ must be dealt directly with Sunstone™ at: sunstonemetalproducts.com/warranty. Warranty issues on the Napoleon BBQ Grill must be dealt directly with Napoleon Grills at: napoleongrills.com/support/warranty-information

Quality and Support Pledge

All Barkman products are guaranteed to meet or exceed the Canadian Standards Association (CSA) standards. We use only superior grade materials and employ stringent quality control measures throughout the manufacturing process to ensure a quality product every time. We also support our products with one of the industry's largest network of dealers and contractors. When you need us, we'll be there to help.

Important – actual colours may vary. Every effort has been made to ensure accuracy in the colour representations found in our product catalogues. However, due to the natural characteristics of concrete, the manufacturing process and print reproduction, actual colours in the final product may vary from that shown.

How to Order

Ordering Barkman products is as simple as calling or visiting one of our many dealers or contractors. Please be ready to specify product style and colour choice if required.

If working directly with a contractor, please be sure to specify Barkman products to ensure Barkman quality. For Winnipeg customers requiring steps, please contact our Winnipeg office directly.

Installation and Project Estimation Support

Barkman provides easy-to-read installation guides that contain simple step-by-step instructions to help make installation a snap. Visit BarkmanConcrete.com to download a copy. Our website also features a handy product calculator that allows you to easily calculate the quantity of Barkman material and accessories.

Colour Blend Information

Pavers, Slabs and Walls

Charcoal – Charcoal
Desert Buff – Various Shades of Buff
Sierra Grey – Buff, Charcoal
Antique Brown – Brown (Reddish), Buff, Charcoal
Old Town – Brown (Earth Tone), Charcoal, Beige
Natural – Natural Grey
Shoreline Slate – Light Grey, Charcoal
Tamarack – Brown (Earth Tone)
Mountain Ash – Light Grey
Autumn Brown – Charcoal, Tan
Ash – Natural, Grey
Sterling – White, Charcoal, Greys

Hazel – Tan, Brown, Buff
Sandstone – Various shades of Brown and Buff, with White
Flint – Charcoal, White, Gold Fleck
Cedar Brown – Various shades of Brown
Weathered Grey – Various shades of Grey
Perfetto Cosmo Black – Charcoal with White Speckles
Perfetto Regency White – White with Black Speckles
Kodiak Brown – Light and Dark Brown
Timber Wolf Grey – Light and Dark Grey

Rosetta

Fon du Lac – Buff, Light Brown, Charcoal
Copper Canyon – Dark Brown, Charcoal
Pacific Grey – Light Grey, Charcoal

Product Changes for 2019

NEW PRODUCTS

Slabs

Arborwood – Timber Wolf Grey, Kodiak Brown

Walls

Bridgewood Wall – Cedar Brown, Weathered Grey
Architextures Closed End Coping

Site Furnishings

Cast Bench with Back
One40Two with Back
Cast Patio Table
Skyline Bench

Kits

Modern Firepit Sierra Grey

Steps

Legacy Steps

DISCONTINUED

Pavers

Holland 8x8 – Natural, Desert Buff, Antique Brown

Slabs

Travertine – all sizes
Round Stepping Stones

Retaining Wall

StackStone Radius – all colours
RomanStack Radius – all colours
Pisa2 20" Corners – all colours
Pisa2 14" Coping – all colours
RomanPisa 14" Coping – all colours
RomanPisa – Desert Buff, Antique Brown
Quarry Stone – 4" Standard
Quarry Stone – 8" Standard
Quarry Stone – 8" Radius
Architextures Coping

Site Furnishings

Pebblestone Patio Tables
Cube Waste Container

Specialty Products

Techniseal – Protectors, Removers, Joint Stabilizers, Application Tools
Paver and Retaining Wall Lights

Steps

Perma Steps

Barkman does its best to ensure accuracy for all measurements of our paving stone. Measurements provided may vary slightly depending on laying application. Best practice is to always have physical product on site before pouring preset structures.

COLOURS

For installation ideas see the Barkman *Spaces at Home* and *Barkman Urban Spaces* catalogues or BarkmanConcrete.com.

Boardwalk Paver (page 15)



Broadway 65mm Paver (page 11)

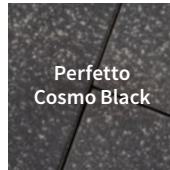
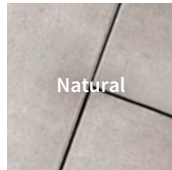

Broadway 100mm Paver (page 16)

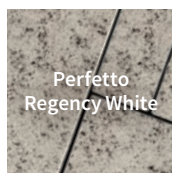
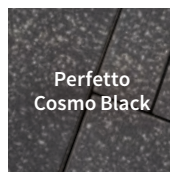
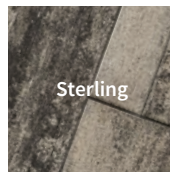

Cobble Paver (page 15)

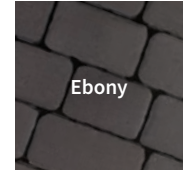

Flagstone Paver (page 5)



Holland Paver (page 8)

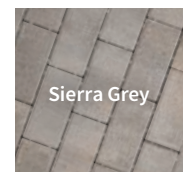
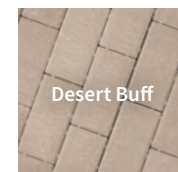
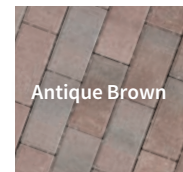
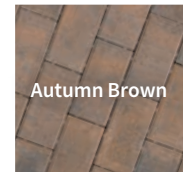
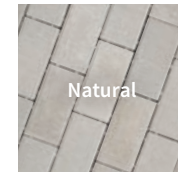

Holland 8cm Paver (page 15)

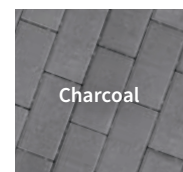
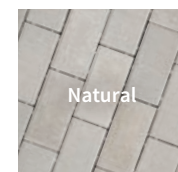

Mesa Flagstone Paver (page 14)



Sterling

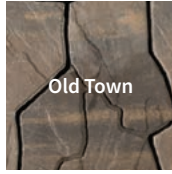

Old Town



Sierra Grey

Navarro Paver (page 14)

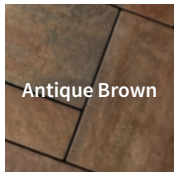

Antique Brown

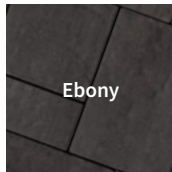

Ebony

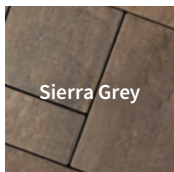

Sierra Grey

Roman Paver (page 9)



Charcoal



Sierra Grey



Desert Buff

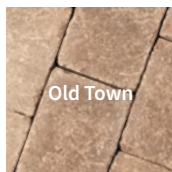

Old Town

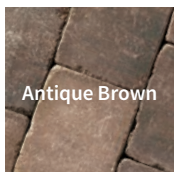

Antique Brown

Verano Paver (page 7)

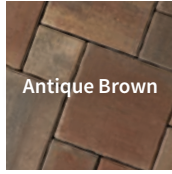

Antique Brown

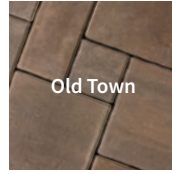

Old Town



Sierra Grey



Charcoal

Villa Paver (page 4)



Charcoal

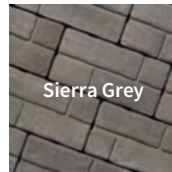

Sierra Grey

Turfstone Eco Paver (page 18)



Natural

I-Con Edger (page 36)



Charcoal



Sierra Grey



Desert Buff

Granite Edger (page 36)



Charcoal



Old Town

Villa Edger (page 36)



Charcoal



Sierra Grey

Bullnose (page 10)

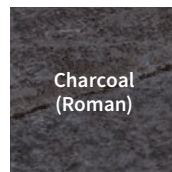

Charcoal
(Roman)

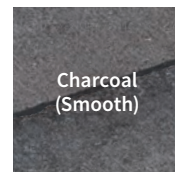

Charcoal
(Smooth)

Arborwood Slab (page 21)

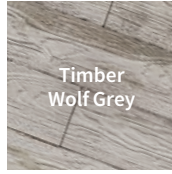
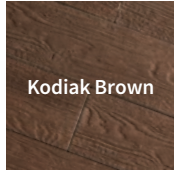

Bridgewood Slab (page 22)



Brookside Slab (pages 24)

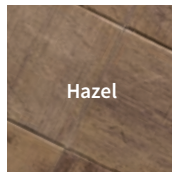
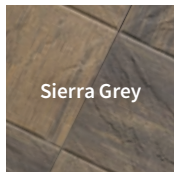

Lexington Tile (pages 25)

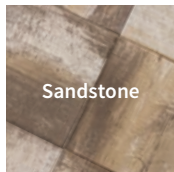
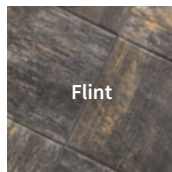
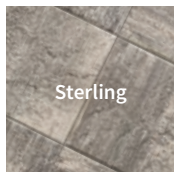

Terra Nova Slab (page 22)

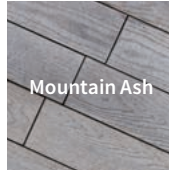
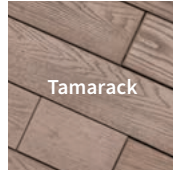

Diamondface Slab (page 26)

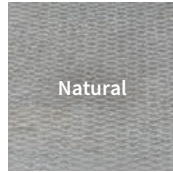

Footing Pads (page 26)



Square Stepping Stone (page 26)



Untumbled Quarry Stone Wall (page 29)

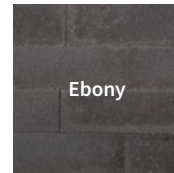

Architextures Wall (page 32)

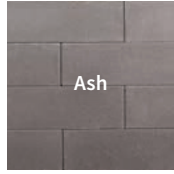
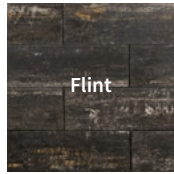

Bridgewood Wall (page 28)

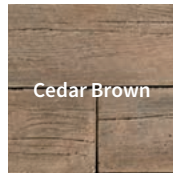

Keystone Compac III Wall (page 33)

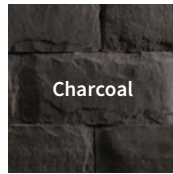

Pisa2 Wall (page 29)

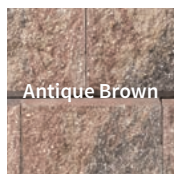
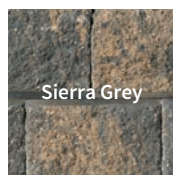

Quarry Stone Wall (page 29)



RomanPisa Wall (page 30)



RomanStack Wall (page 28)

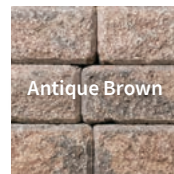

StackStone Wall (page 28)

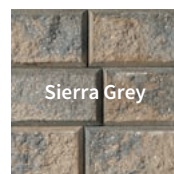
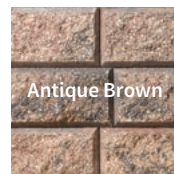
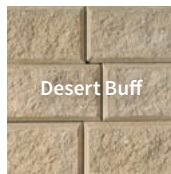

Harvest Grove Outdoor Kitchen Kits (page 47-49)

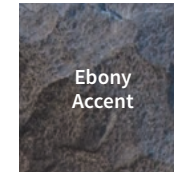

Harvest Grove Outdoor Kitchen Kit Countertop (page 47-49)

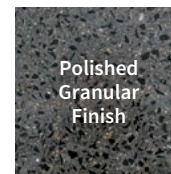

Rosetta Firepit and Pillar Kits (pages 46)

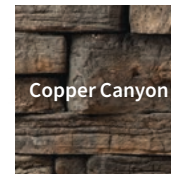

Stone Oasis Square Firepit Kits (page 45)

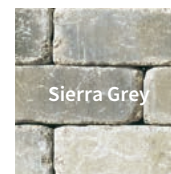

Modern Firepit (pages 44)

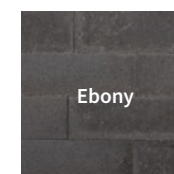
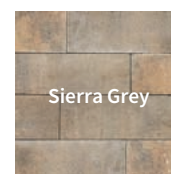

Stone Oasis Fireplace, and Pillar Kits (pages 43 & 46)



Stone Oasis Circle Patio Kit (page 44)



Stone Oasis Circle Firepit Kits (page 45)



Site Furnishings GFRC (pages 57-62)

Surface Applied Colour

Available in smooth or textured finish

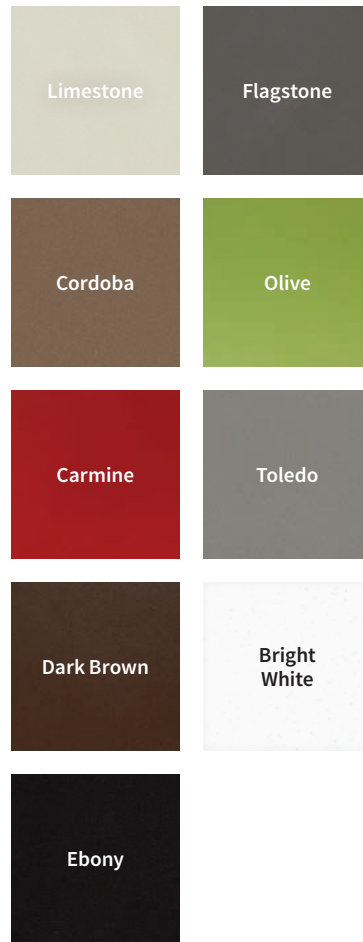

Raw Integral Colour (pigmentation throughout the product with no applied finish, ideal for high traffic.) Available in smooth only.

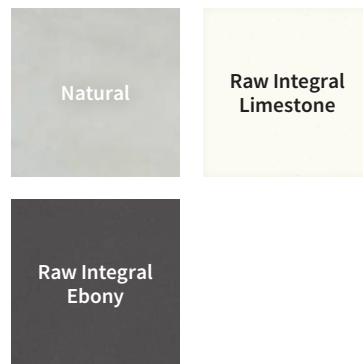

Custom colours for GFRC are available at a premium 15%

GFRC Surface finishes are available in textured or smooth

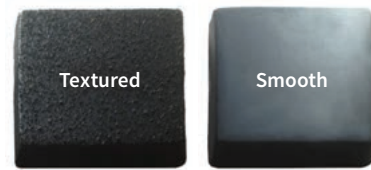

Classic Precast finishes (pages 53-56)

Standard Colour



Premium Colours

Premium Charcoal Pebblestone and Natural Sandblast finishes add 25% to cost.



Cast Planters finishes (pages 51)



Square Waste Container Accent Colours

Lid and Band Colours



Rosetta®
Dimensional Flagstone (page 24)



Rosetta®
Grand Flagstone (page 23)



Rosetta®
Belvedere Wall (page 30)



Rosetta®
Dimensional Wall (page 31)



Rosetta®
Kodah Wall (page 31)



Rosetta®
Outcropping Wall (page 32)



STEINBACH OFFICE

152 Brandt Street, Steinbach, MB R5G 0R2
T 204 326 3445 or 1 800 461 2278
F 204 326 5915
Steinbach@BarkmanConcrete.com

WINNIPEG OFFICE

901 Gateway Road, Winnipeg, MB R2K 3L1
T 204 667 3310 or 1 800 342 2879
F 204 663 4854
Winnipeg@BarkmanConcrete.com

CALGARY OFFICE

813 McCool Street, Box 1136,
Crossfield, AB T0M 0S0
T 403 946 4630 F 403 946 4631
Calgary@BarkmanConcrete.com

VANCOUVER OFFICE

2104-290 Newport Drive,
Port Moody, BC V3H 5N2
T 778 689 7670 or 1 800 461 2278
F 604 949 0321
Vancouver@BarkmanConcrete.com

SASKATOON DISTRIBUTION CENTER

3550 Idylwyld Drive North, Saskatoon, SK
T 306 549 7544

KELOWNA DISTRIBUTION CENTER

1904 Old Okanagan Highway, Westbank, BC
T 403 946 4630

SURREY DISTRIBUTION CENTER

8157 132nd Street, Surrey, BC
T 403 946 4630

barkman[™]

BarkmanConcrete.com

